

CZ ÚVOD

Již více jak 15 let pracujeme na budování pozice kvalitativního a designového lídra trhu s nábytkovými dvířky. Během tohoto období se značka **PROFORM** stala uznávanou obchodní známkou nejen v Česku a na Slovensku, ale i v Evropě. Neustále rozšiřujeme nabídku našich produktů a služeb tak, aby odpovídaly potřebám trhu. Kromě pestré, pečlivě připravené a neustále aktualizované nabídky nábytkových dvířek a dekoračních panelů nabízíme našim zákazníkům širokou škálu stolařských služeb, včetně výroby korpusů na míru. Jsme hrdí na to, že vývoj našich produktů je doprovázen neustále aktualizovanými marketingovými materiály, technickou dokumentací a inovativním on-line objednávkovým systémem. Mezi naše klienty dnes patří nejen výrobci nábytku, nábytková studia a montážní firmy. Díky technologickým znalostem, rozsáhlým znalostem materiálů a našim technickým možnostem, stále intenzivněji spolupracujeme s designéry a architekty, kteří se podílejí na významných investičních projektech. Věnujte pozornost detailům - rozlišují proprietární produkty od padělků!

SK ÚVOD

Už viac ako 15 rokov pracujeme na budovaní pozície kvalitného a dizajnového lídra trhu s nábytkovými dvierkami. Počas tohto obdobia sa značka **PROFORM** stala uznávanou obchodnou známkou nielen v Česku a na Slovensku, ale aj v Európe. Neustále rozširujeme ponuku našich produktov a služieb tak, aby zodpovedali potrebám trhu. Okrem pestrej, starostlivo pripravenej a aktualizovanej ponuky nábytkových dvierok a dekoračných panelov ponúkame našim zákazníkom širokú škálu stolárskych služieb, vrátane výroby korpusov na mieru. Sme hrdí na to, že vývoj našich produktov je sprevádzaný neustále aktualizovanými marketingovými materiálmi, technickou dokumentáciou a inovatívnym on-line objednávkovým systémom. Medzi našich klientov patria nielen výrobcovia nábytku, nábytkové štúdiá a montážne firmy. Vďaka technologickým znalostiam, rozsiahlym znalostiam materiálov a našim technickým možnostiam, stále intenzívnejšie spolupracujeme s dizajnérmí a architektmi, ktorí sa podieľajú na významných investičných projektoch. Venujte pozornosť detailom - rozlišujú proprietárne produkty od falzifikátov!

EN INTRODUCTION

We have been working hard to become a leader in production and quality for more than 15 years. During this period, the **PROFORM** brand has become a recognizable trademark in Czech Republic, Slovakia and Europe. We keep expanding our range of products and services to address the needs of the market. Apart from a varied, carefully prepared and constantly updated selection of cupboard fronts and decorative panels, we offer our customers a wide range of carpentry services, including the production of ready-to-size furniture bodies. We pride ourselves that our product development is accompanied by constantly updated marketing material, technical documentation as well as an innovative Customer Service Platform. Today, our clients include not only furniture manufacturers, furniture studios and assembly companies. Thanks to our technological expertise, extensive knowledge of materials and our technical capabilities, we keep intensifying cooperation with designers and architects, participating in major investment projects. Pay attention to details – they distinguish proprietary products from fakes!



LAK MAT – LAK VYSOKÝ LESK / LAK MAT – LAK VYSOKÝ LESK / MATT LACQUER - HIGH GLOSS LACQUER

CZ:

Pro nejnáročnější zákazníky jsou lakovaná dřívka nejlepší volbou – možnost výběru z palety barev RAL a NCS umožní splnit každé Vaše přání.

Jednou z nejčastějších povrchových úprav je matný lak (stupeň lesku 20) nebo vysoký lesk (stupeň lesku 99). Nejvyššího povrchu je dosaženo postupným nanášením 5-8 vrstev laku na nosný materiál (frézovaná MDF deska). V případě vysokého lesku je pro dosažení zrcadlového efektu povrch v několika krocích leštěn.

Důležité! Používáme pouze barvy, které jsou certifikovány pro styk s potravinami.

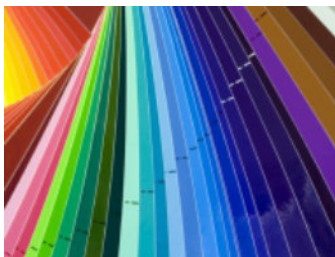

SK:

Pre najnáročnejších zákazníkov sú lakované dviierka najlepšou voľbou - možnosť výberu z palety farieb RAL a NCS umožní splniť každé Vaše prianie.

Jednou z najčastejších povrchových úprav je matný lak (stupeň lesku 20) alebo vysoký lesk (stupeň lesku 99). Najkvalitnejšieho povrchu je dosiahnuté postupným nanášením 5-8 vrstiev laku na nosný materiál (frézovaná MDF doska). V prípade vysokého lesku je pre dosiahnutie zrkadlového efektu povrch v niekoľkých krokoch leštený.

Dôležité! Používame len farby, ktoré sú certifikované pre styk s potravinami.

EN:

Lacquer-coated furniture fronts are the best option for the most demanding needs - the ability to choose from the full RAL/NCS chart allows us to fulfil every requirement.

The most popular finish is matt (gloss grade 20) and high gloss (gloss grade 99). In order to guarantee the highest quality, the base material (milled MDF board) is coated with only around 5-8 layers of lacquer. To achieve a glass-like surface of high gloss fronts, they are additionally polished multiple times.

Caution! - we only use lacquers which are attested for food contact.

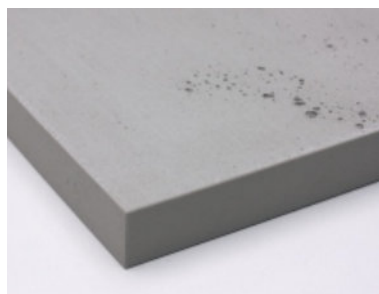

IMI - BETON / IMI - BETON / IMI - BETON

CZ:

IMI-BETON vypadá jako beton, na dotek je jako beton, ale není to beton. Jedná se o moderní materiál – flexibilní minerální hmotu s obsahem přírodního mramoru. Jeho předností je nízká hmotnost, a proto má mnohem širší oblast použití. IMI-BETON umožňuje vytvořit interiéry se vzhledem betonu, jejichž realizace klasickým způsobem by byla velmi drahá a časově náročná. Tento materiál nemá téměř žádná omezení a lze jej kombinovat s různými materiály, čímž se vytvoří v interiéru jedinečná atmosféra.

SK:

IMI-BETON vyzerá ako betón, na dotyk je ako betón, ale nie je to betón. Jedná sa o moderný materiál - flexibilnú minerálnu hmotu s obsahom prírodného mramoru. Jeho prednosťou je nízka hmotnosť, a preto má oveľa širšiu oblasť použitia. IMI-BETON umožňuje vytvoriť interiéry so vzhľadom betónu, ktorých realizácia klasickým spôsobom by bola veľmi drahá a časovo náročná. Tento materiál nemá takmer žiadne obmedzenia a možno ho kombinovať s rôznymi materiálmi, čím sa vytvorí v interiéri jedinečná atmosféra.

EN:

It looks like concrete. It feels like concrete. However, it is not. Imi - Beton is innovative composite material made of hydro-mass. According to that, you can design your interior giving it concrete-look especially, when it is impossible to use cement. The weight is primary advantage of syntetic concrete. Moreover, in comparison to autentic concrete, Imi - Beton is smooth and warm to the touch and there is no dust. It is perfect material to create a unique atmosphere.

imi
SURFACE DESIGN



CZ: surová MDF
SK: surová MDF
EN: raw



CZ: síla
SK: hrúbka
EN: thickness



CZ: vzor, jehož základním tvarem je modul 600/600 mm, což znamená, že návaznost frézování je každých 600/600 mm
SK: vzor, ktorého základným tvarom je modul 600/600 mm, čo znamená, že nadväznosť frézování je každých 600/600 mm
EN: basic pattern contained in the 600/600 mm unit which means that the continuation of the patterns takes place every 600/600 mm



CZ: ALVIC
SK: ALVIC
EN: ALVIC



CZ: hloubka frézování
SK: hĺbka frézování
EN: milling depth



CZ: fólie UN,DC,DM,PT
SK: fólia UN,DC,DM,PT
EN: foil UN,DC,DM,PT



CZ: akryl
SK: akryl
EN: acrylic



CZ: vzor, jehož základním tvarem je modul 1200/600 mm, což znamená, že návaznost frézování je každých 1200/600 mm
SK: vzor, ktorého základným tvarom je modul 1200/600 mm, čo znamená, že nadväznosť frézování je každých 1200/600 mm
EN: basic pattern contained in the 1200/600 mm unit which means that the continuation of the patterns takes place every 1200/600 mm



CZ: černá MDF + fólie
SK: čierna MDF + fólia
EN: black MDF + foil



CZ: černá MDF + dýha
SK: čierna MDF + dyha
EN: black MDF + veneer



CZ: fólie vysoký lesk
SK: fólia vysoký lesk
EN: high gloss foil



CZ: Imi-beton
SK: Imi-beton
EN: Imi-beton



CZ: MDF + dýha
SK: MDF + dyha
EN: MDF + veneer



CZ: lak matný
SK: lak matný
EN: matt lacquer



CZ: oboustranný panel
SK: obojstranný panel
EN: double-sided



CZ: lak vysoký lesk
SK: lak vysoký lesk
EN: high gloss lacquer



CZ: masivní dřívka
SK: masivné dvierka
EN: solid wood



CZ: ALVIC je španělská společnost s globální působností, lídr ve výrobě vysoce kvalitních panelů a komponent pro nábytkářský průmysl. Působí ve více než 100 zemích na 5 kontinentech, s originálními kolekcemi LUXE, ZÉNIT a SYNCRON, které jsou na světovém trhu jedinečné. ALVIC vyrábí především lakované MDF desky a dřevotřískové desky s fantastickými dekory, krásnými barvami a jedinečnými vlastnostmi.

Kolekce **LUXE** zahrnuje řadu vzorů ve vysokém lesku.

ZÉNIT je nabídka pro zájemce o matné povrchy, které jsou odolné proti otiskům prstů a mají skvělé mechanicko-fyzikální vlastnosti.

Pokud preferujete povrchy s přirozenou, synchronní strukturou, naleznete v nabídce ALVIC řadu **SYNCRON** věrně imitující dřevo nebo kámen.

SK: ALVIC je španielska spoločnosť s globálnou pôsobnosťou, líder vo výrobe vysoko kvalitných panelov a komponentov pre nábytkársky priemysel. Pôsobí vo viac ako 100 krajinách na 5 kontinentoch, s originálnymi kolekciami LUXE, ZÉNIT a SYNCRON, ktoré sú na svetovom trhu jedinečné. ALVIC vyrába predovšetkým lakované MDF dosky a drevotrieskové dosky s fantastickými dekormi, krásnymi farbami a jedinečnými vlastnosťami.

Kolekcia **LUXE** zahŕňa množstvo vzorov vo vysokom lesku.

ZÉNIT je ponuka pre záujemcov o matné povrchy, ktoré sú odolné proti odtlačkom prstov a majú skvelé mechanicko-fyzikálne vlastnosti.

Pokiaľ preferujete povrchy s prirodzenou, synchronnou štruktúrou, nájdete v ponuke ALVIC rad **SYNCRON** verne imitujúce drevo alebo kameň.

EN: ALVIC is a Spanish company with a global reach, a leader in the production of high-quality furniture panels and components for the furniture and decoration industry. Present in over 100 countries on 5 continents, with original LUXE, ZÉNIT and SYNCRON collections, which are unique on the global market.

The Spanish manufacturer Alvic produces mainly MDF and chipboard furniture boards, varnished, with fantastic decors, beautiful colors and unique properties.

The Luxe collection includes a range of very high-gloss patterns.

Zenit is an offer for those interested in matte surfaces resistant to fingering and with excellent mechanical properties.

If someone prefers surfaces with a natural, synchronous structure, he will find in this offer the Synchron line with patterns that perfectly imitate wood or stone.

Luxe®

Zénit
High Resistance Surface

Synchron®
structured panel LINE

Vysoký lesk
Vysoký lesk
High gloss

CZ: Povrch LUXE má vysoce lesklý povrch se zrcadlovým efektem a vysokou odolností proti poškrábání. Navíc má překvapivé technické vlastnosti, které umožní jeho široké využití při výrobě nábytku a dekorací.

SK: Povrch LUXE má vysoko lesklý povrch so zrkadlovým efektom a vysokou odolnosťou proti poškrabaniu. Navyše má prekvapivé technické vlastnosti, ktoré umožnia jeho široké využitie pri výrobe nábytku a dekorácií.

EN: The LUXE surface has a high-gloss finish, with a mirror effect and high resistance. Moreover, it has surprising technical properties that make it a material that can be widely used in the production of furniture and decorations.

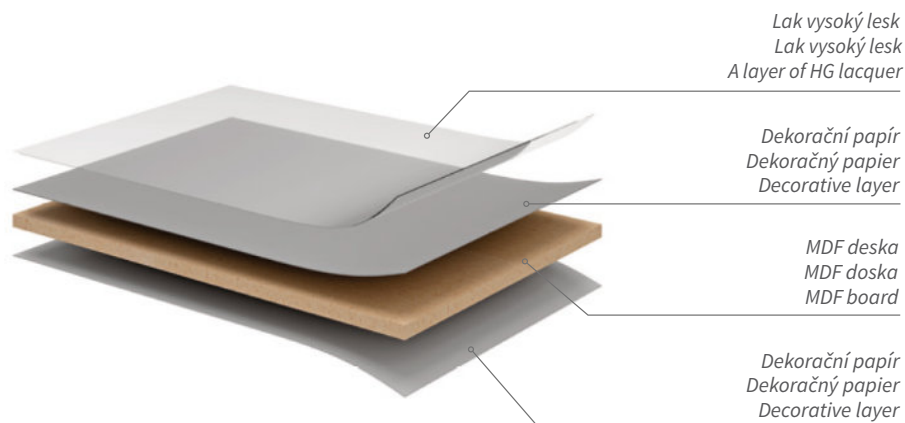

stálost barev
stálosť farieb
color durability



vysoký lesk
vysoký lesk
high gloss



stupeň lesk 101 GU
stupeň lesk 101 GU
Glanz 101 GU



zrcadlový efekt
zrkadlový efekt
mirror effect



snadné čištění
lahké čistenie
easy to clean



šetrný vůči životnímu prostředí
šetrný voči životnému prostrediu
eco-friendly



odolnost proti poškrábání
odolnosť proti poškrabaniu
scratch resistant



odolnost proti skvrnám
odolnosť proti škvrnám
stain resistant



dlouhá životnost
dlhá životnosť
long durability



antibakteriální povrch
antibakteriálny povrch
antibacterial



vysoká odolnost proti oděru
vysoká odolnosť proti oderu
abrasion resistant



voděodolnot (bariérový efekt)
vodeodolnosť (bariérový efekt)
moisture resistance

CZ: ZENIT je lakovaný povrch supermat s jemnou, sametovou texturou, která dodává eleganci a jemnost každému prostoru. Skládá se z vysoce kvalitní MDF desky, na kterou je lisován dekorační papír napuštěný pryskyřicemi a přísadami. Unikátní receptura pryskyřice a přísad, vyvinutá společností ALVIC, zajišťuje nejlepší povrchovou úpravu.

SK: ZENIT je lakovaný povrch supermat s jemnou, sametovou textúrou, ktorá dodáva eleganciu a jemnosť každému priestoru. Skladá sa z vysoko kvalitnej MDF dosky, na ktorú je lisovaný dekoračný papier napuštěný živícami a prísadami. Unikátna receptúra živice a prísad, vyvinutá spoločnosťou ALVIC, zaisťuje najlepšiu povrchovú úpravu.

EN: Zenit is a lacquered Supermatt surface with a soft, velvety texture that adds elegance and softness to any space. It consists of high-quality MDF board on which decorative paper impregnated with resins and additives is embossed. The unique formula of resin and additives, developed by ALVIC, ensures the best finish.

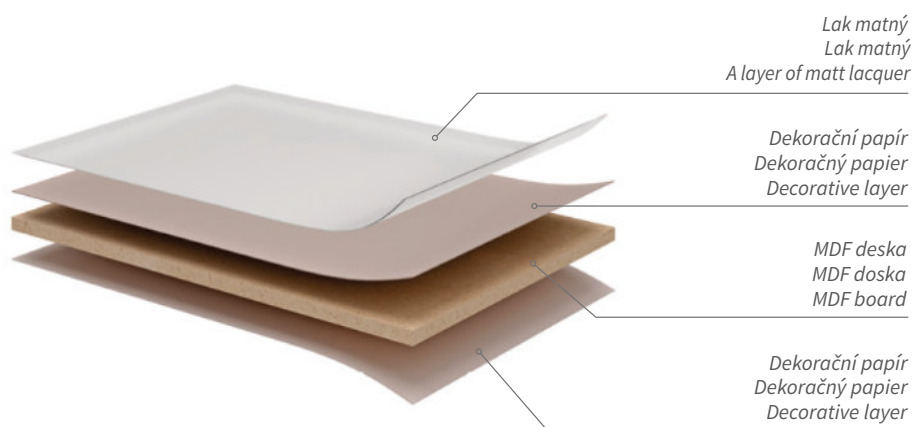

stálost barev
stálost farieb
color durability



hedvábný mat
hodvábný mat
silky touch



odolnosť proti otiskům prstů
odolnosť proti odtlačkom prstov
Fingerprint free



odolnosť proti škvrnám
odolnosť proti škvrnám
stain resistant



snadné čištění
lahké čistenie
easy to clean



šetrný vůči životnímu prostředí
šetrný voči životnému prostrediu
eco-friendly



odolnosť proti poškrábání
odolnosť proti poškrábaniu
scratch resistant



voděodolnot (bariérový efekt)
vodeodolnosť (bariérový efekt)
moisture resistance



dlouhá životnost
dlhá životnosť
long durability



antibakteriální povrch
antibakteriálny povrch
antibacterial



vysoká odolnosť proti oděru
vysoká odolnosť proti oderu
abrasion resistant

Texturované
Texturované
Structure

CZ: SYNCRON jsou texturované povrchy s řadou atraktivních vzorů, které dodávají prostoru přirozenosti a zvyšují jeho dekorativní hodnotu. Vyrábí se na bázi dřevotřískové desky, na kterou je lisován dekorační papír impregnovaný pryskyřicemi a přísadami.

SK: SYNCRON sú textúrované povrchy s množstvom atraktívnych vzorov, ktoré dodávajú priestoru prirodzenosti a zvyšujú jeho dekoratívnu hodnotu. Vyrába sa na báze drevotrieskovej dosky, na ktorú je lisovaný dekoračný papier impregnovaný živícami a prísadami.

EN: Syncron are textured surfaces composed of an attractive range of patterns, giving the space a great deal of naturalness and increasing decorative values. It is made on a granular basis, onto which decorative paper impregnated with resins and additives is pressed.

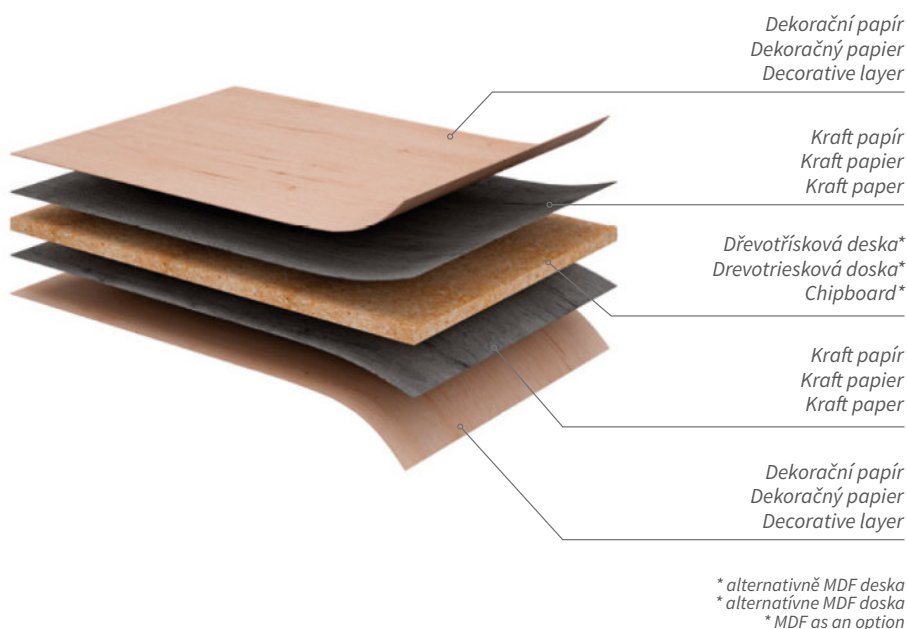

stálost barev
stálost farieb
color durability



přírodní provedení
přírodné prevedenie
natural finishes



odolnost proti skvrnám
odolnosť proti škvrnám
stain resistant



snadné čištění
ľahké čistenie
easy to clean



šetrný vůči životnímu prostředí
šetrný voči životnému prostrediu
eco-friendly



dlouhá životnost
dlhá životnosť
long durability



antibakteriální povrch
antibakteriálny povrch
antibacterial



Stolová podnož: **MB 21**
Stolová podnož
Base

stoly Proform

Stoly Proform / Proform-tables

Stolová deska: **Alvic Sierra + RAL 9011**
Stolová deska
Table top

 **form**[®]
DESIGN QUALITY TECHNOLOGY





Stolová podnož: **Olimp**
Stolová podnož
Base

Stolová deska: **Alvic Oriental Black + RAL 7015**
Stolová deska
Table top

form[®]
DESIGN QUALITY TECHNOLOGY



proform[®]

DESIGN QUALITY TECHNOLOGY



NÁBYTKOVÁ DVÍŘKA

CZ: Nábytková dvířka jsou nejrepresentativnější částí nábytku, dávají mu výraz a charakter, což v konečném důsledku tvoří ráz celého interiéru. Proto by jejich výběr měl být velmi dobře promyšlený.

Při tomto důležitém rozhodování ve smyslu estetiky (vzoru a barvy) nesmíme zapomínat, že se jedná o volbu na několik let, proto mají velký význam i užitné vlastnosti, jako je kvalita a životnost. To může zajistit pouze použití nejkvalitnějších značkových surovin a materiálů ve spojení s důkladnými technologickými znalostmi a péčí. Chceme, aby Vám vybraná dvířka dělala radost co nejdéle!

Nábytková dvířka PROFORM nabízíme v mnoha variantách povrchové úpravy od fóliovaných, přes akrylová, lakovaná, dýhovaná až po různé fantazie.

Z širokého spektra vzorů, materiálů a barev si každý snadno najde to pravé. Zákazníkům hledajícím něco výjimečného, dáváme možnost vytváření vlastních, neopakovatelných dvířek.

Naše dvířka jsou pro Vás volba bez kompromisů!

NÁBYTKOVÉ DVIERKA

SK: Nábytkové dvierka sú najrepresentatívnejšie časti nábytku, dávajú mu výraz a charakter, čo v konečnom dôsledku tvorí ráz celého interiéru. Preto by ich výber mal byť veľmi dobre premyslený.

Pri tomto dôležitom rozhodovaní v zmysle estetiky (vzoru a farby), nesmieme zabúdať, že sa jedná o voľbu na niekoľko rokov, preto majú veľký význam aj užitkové vlastnosti, ako je kvalita a životnosť. To môže zabezpečiť iba použitie najkvalitnejších značkových surovín a materiálov v spojení s dôkladnými technologickými znalosťami a starostlivosťou. Chceme, aby Vám vybrané dvierka robili radosť čo najdlhšie!

Nábytkové dvierka PROFORM ponúkame v mnohých variantoch povrchovej úpravy od fóliovaných, cez akrylové, lakované, dýhované až po rôzne fantázie.

Zo širokého spektra vzorov, materiálov a farieb si každý ľahko nájde to pravé. Zákazníkom hľadajúcim niečo výnimočné, dávame možnosť vytvárania vlastných, neopakovatelných dvierok.

Naše dvierka sú pre Vás voľba bez kompromisov!

FURNITURE FRONTS

EN: Furniture fronts are the most representative part of a furniture, giving it character and therefore creating the desired atmosphere of the entire room. Because of the above, selecting the right furniture front should be particularly well-considered.

While making an important decision in regard to the aesthetics, choosing the designs and colours, we should not forget about usability, quality and durability of the product, as it will serve us for years. Only using recognised materials of the best quality, combined with the uttermost diligence and an in-depth technological knowledge guarantees the highest quality and durability of the final product. Our aim is for you to be able to enjoy our furniture fronts for as long as possible! Our front assortment is available with a PCV foil, acrylic, lacquer, veneer or imaginative finish. With our wide range of materials, designs and colours you are sure to find something you will love. For anybody looking for unique creations, we offer a possibility of creating individual, one-of-a-kind fronts.

Our fronts are your uncompromising choice!



U01

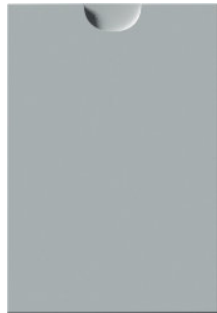

U02



U03

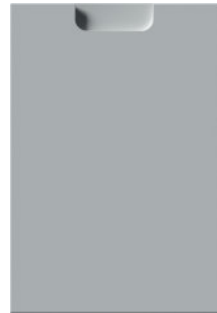

U04



U05



U06

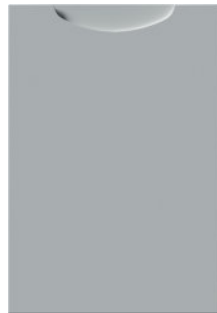

U07

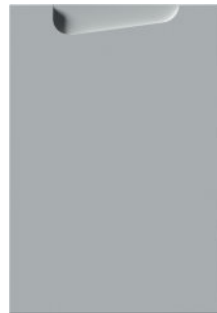

U08

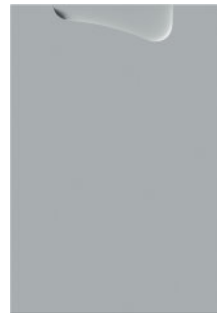

U09

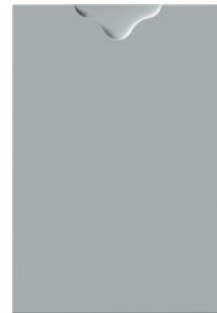

U10



U11



U12



U13



U14



U15



Typ-B*



Typ-D*



Typ-F*



Typ-G*



Typ-I*



Typ-J*



Typ-K*



Typ-P*



UAL-1



UAL-2

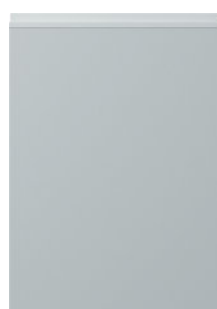

UAL-5

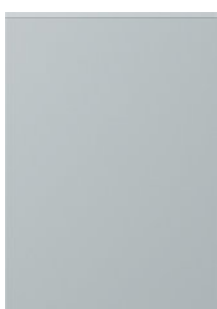

UAL-6



UAL-7
VÍCE VARIANT PROVEDENÍ



UAL-8
VÍCE VARIANT PROVEDENÍ



W001



W002



W003



W004



W005



W006



W007



W008
VÍCE VARIANT PROVEDENÍ



W009
VÍCE VARIANT PROVEDENÍ

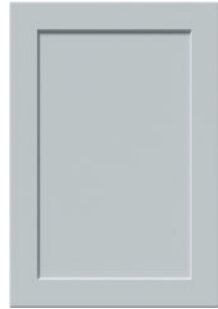

W009/55/bp



W010



W011



W012



W013

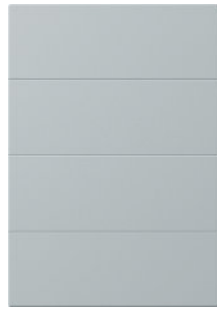

W014
VÍCE VARIANT PROVEDENÍ



W015



W016



W017



W018

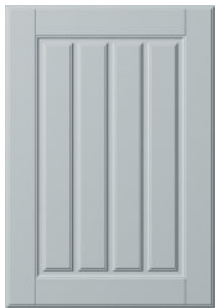

W019



W020



W021



W022



W023



W024



W025



W026



W027



W028

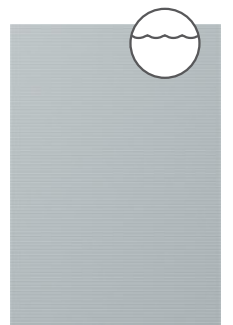

W029



W030



W031



W032



W033



W034



W035



W036



W037



W038



W039



W040



W041*



W042*

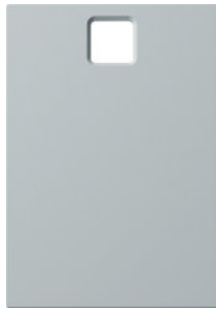

W043*



W044*



W045*

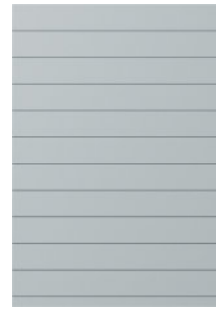

W046*



W047*



W048*



W049



W050

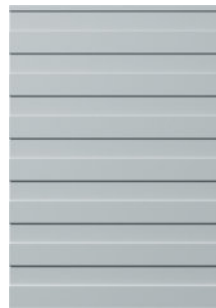

W051*



W052



W053



W055



W056



W057



W058



W059



W060

VÍCE VARIANT PROVEDENÍ



W061



W062



W063



W064

- * tvary dvířek prezentované jen na webové stránce
- * tvary dvierok prezentované iba na webovej stránke
- * patterns presented only on the website

imi

SURFACE DESIGN

Imi-Beton



© Niessing / Fotograf: Luis Engels



U01

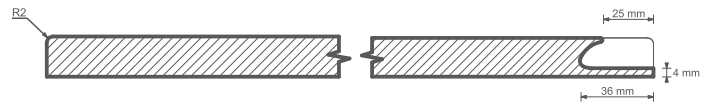

U02

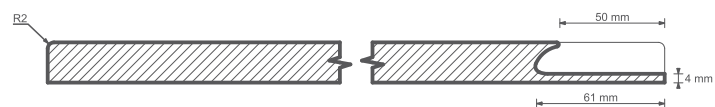
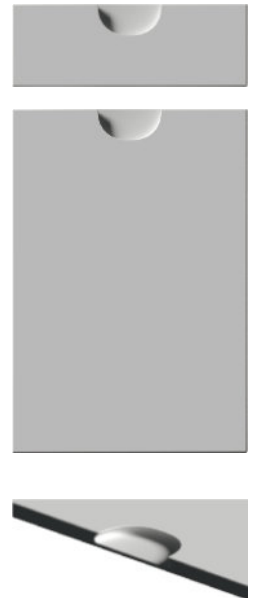

U03

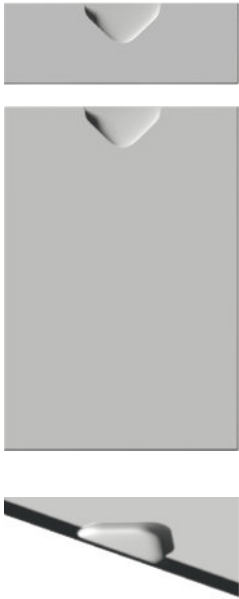

PT 5024

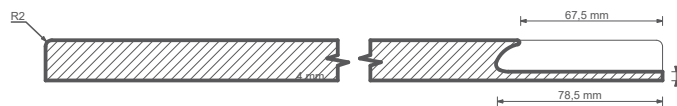

U04

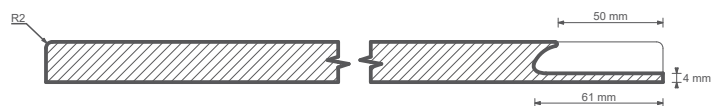
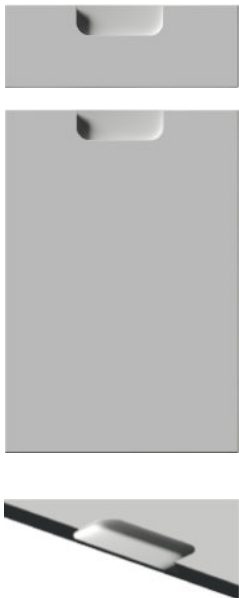



U05

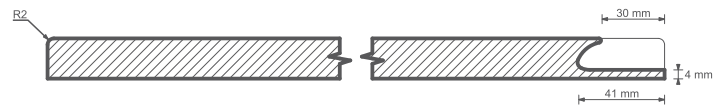
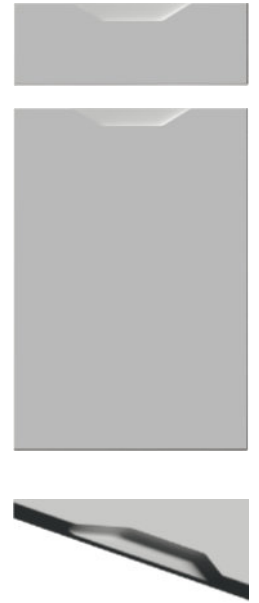

U06

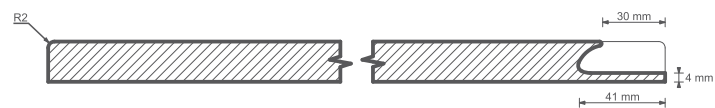
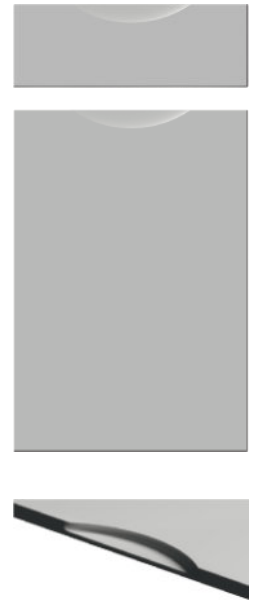

U07

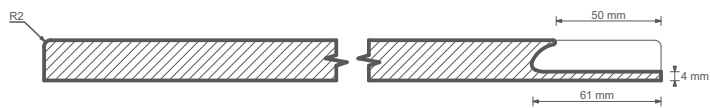
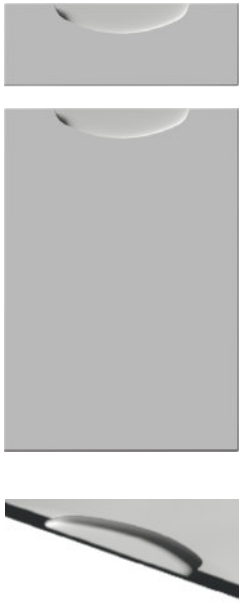

U08

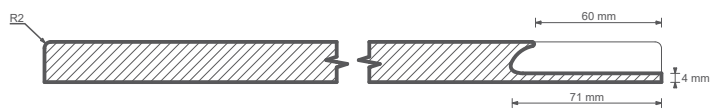
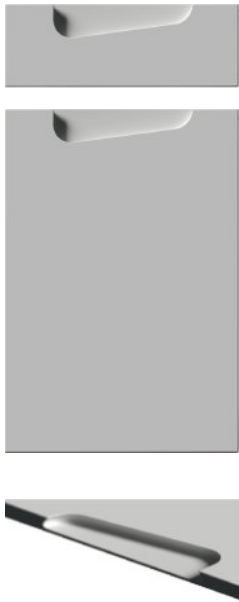



U09

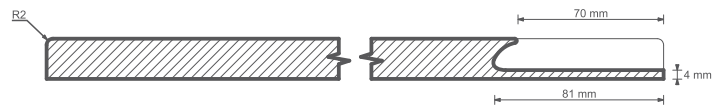
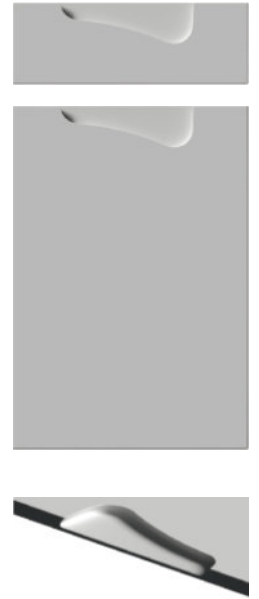

U10

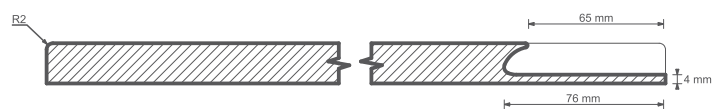
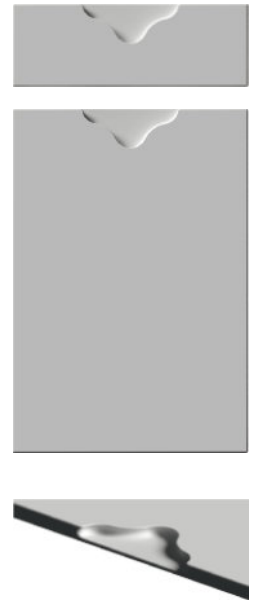

U11

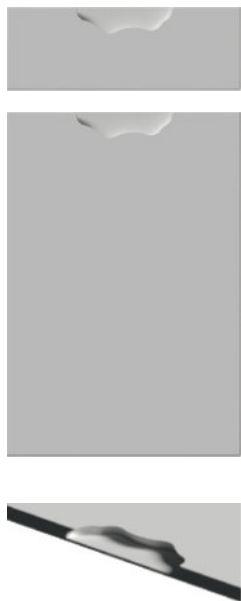

PT 5001

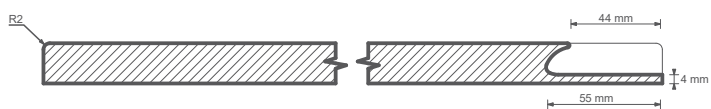

U12

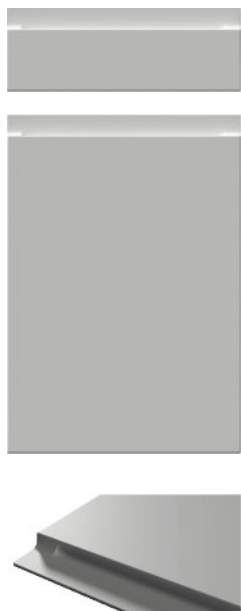

PT 5000



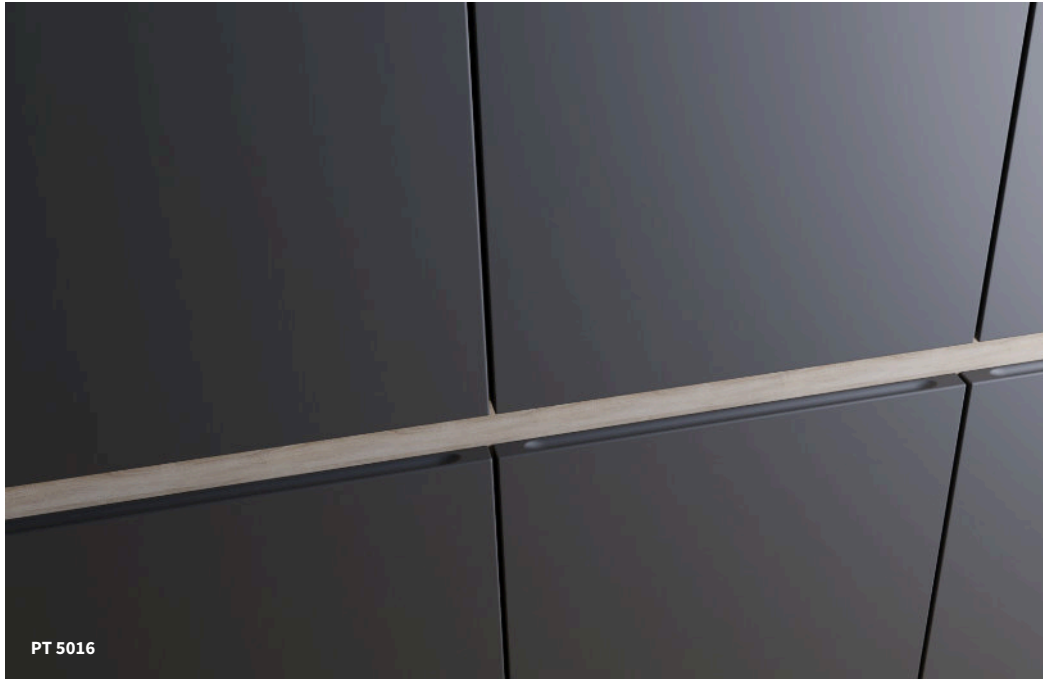

U13

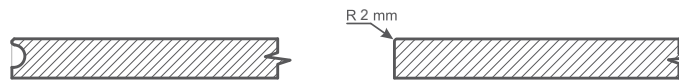
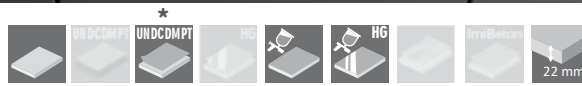
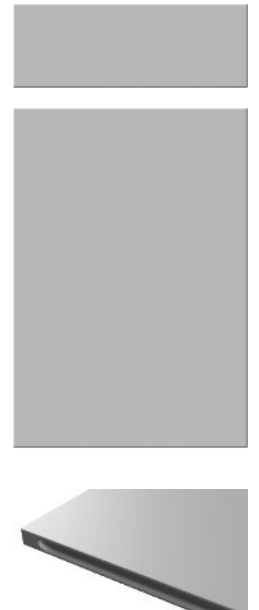

U14

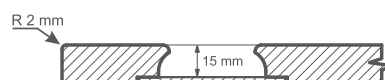
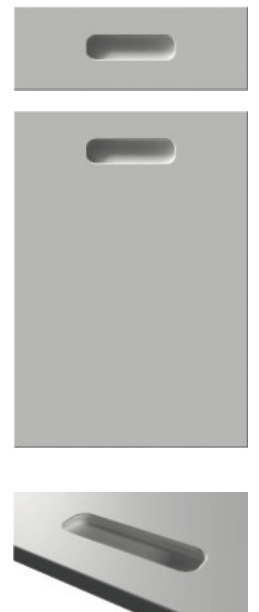

U15

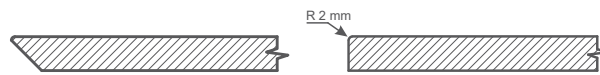
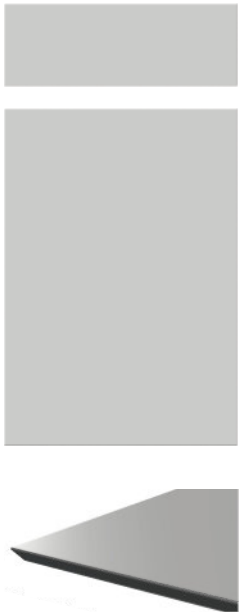

U16

NEW!

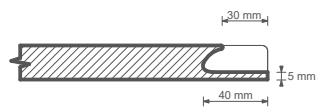

U16/1

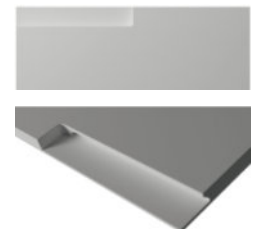



HG 9700

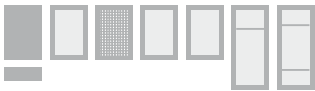

W001

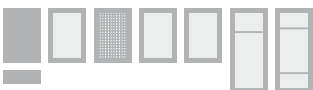

W002



W003

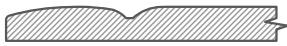

W004

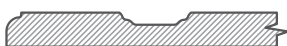
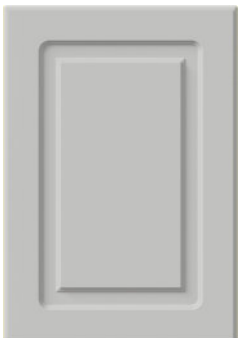



W005

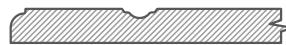
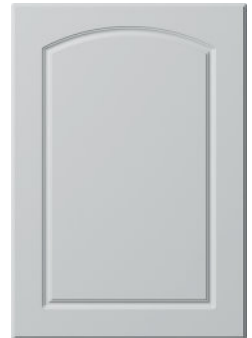

W006

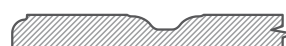
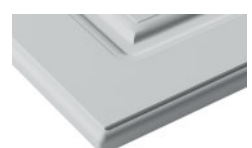

W007



W008



PT 5024

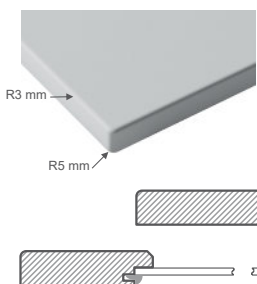

Variants provedení (rádius na hraně / rádius rohu)
 Variants prevedenia (rádius na hrane / rádius rohu)
 Variants (edge radius / corner radius)
 W008/3/5, W008/3/3, W008/3/0, W008/2/2, W008/2/0

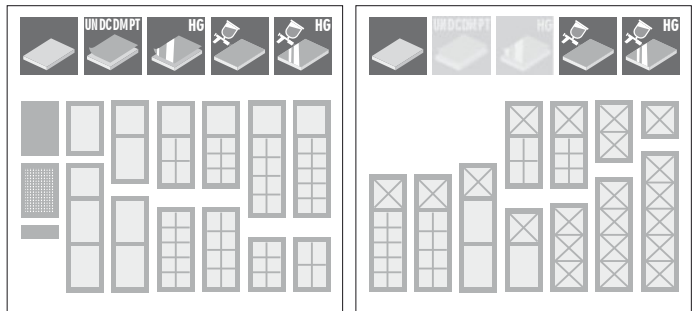



W009

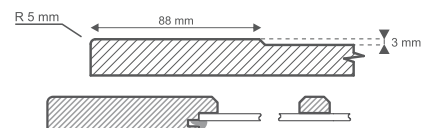
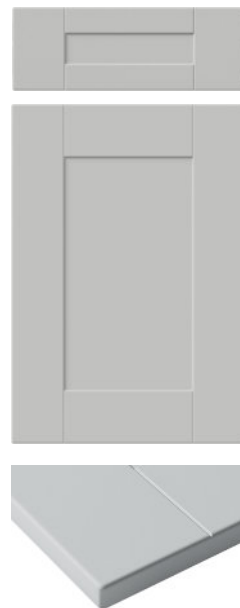

Variety provedení (šířka rámečku)
 Varianty prevedenia (šířka rámčeku)
 Variants (frame width)
 W009/7, W009/6

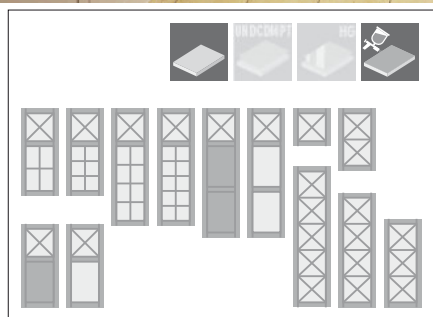
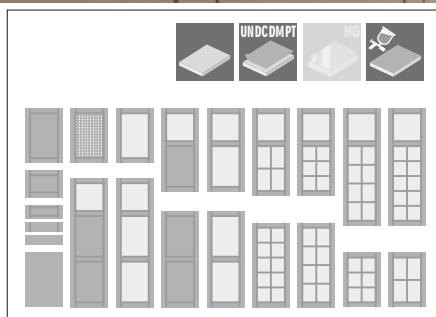

PT 5024

W009/55/bp

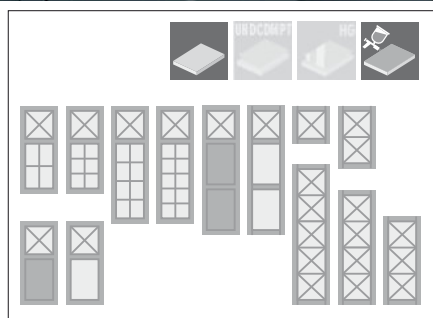
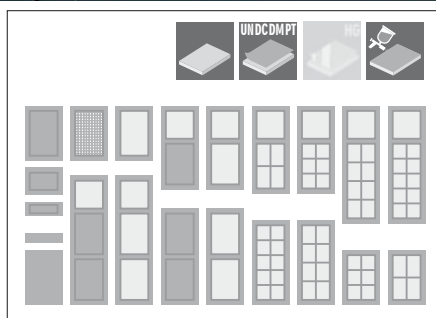
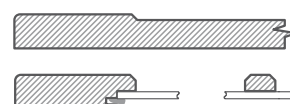
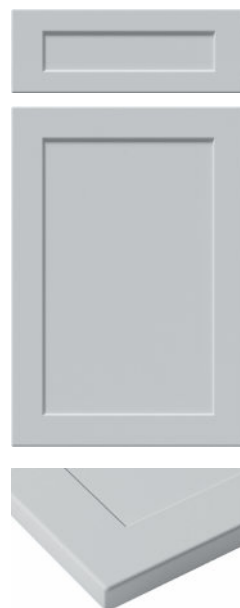

W010

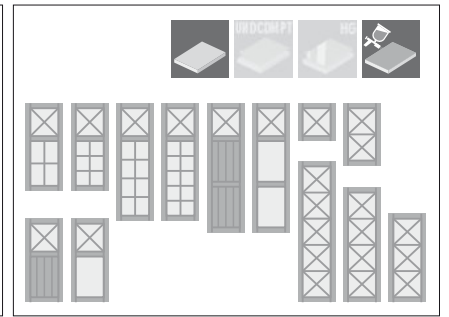
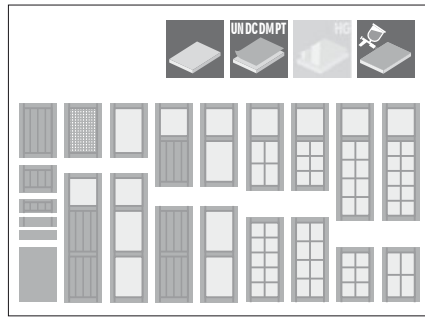
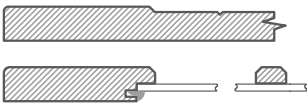
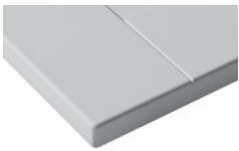

W011

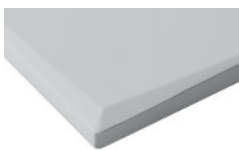



PT 5006

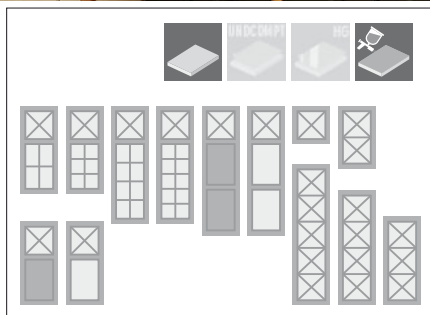
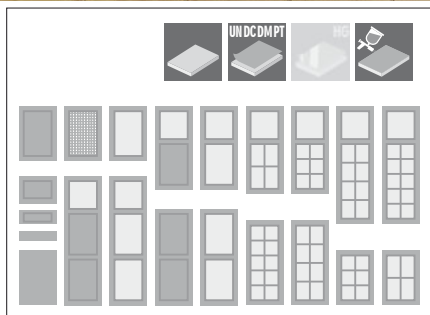

W012

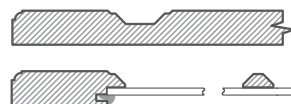

W013



W014

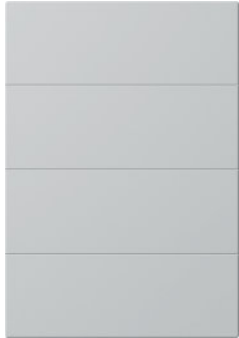

143 mm

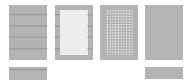
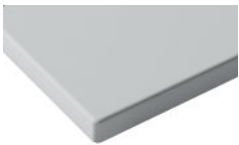

Varianty provedení (vzdálenost drážek)
 Variants prevedenia (vzdialenosť drážok)
 Variants (groove distance)
 W014/143, W014/130

W015





W016



W017



RAL 5014

W018

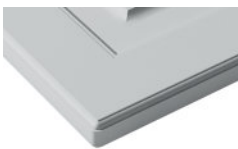

W019

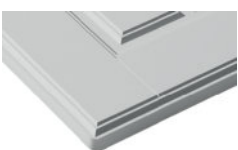
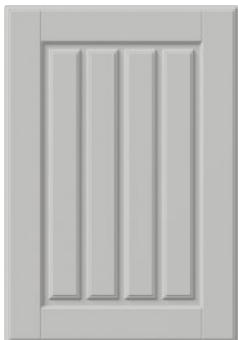



W020

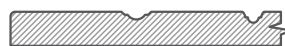
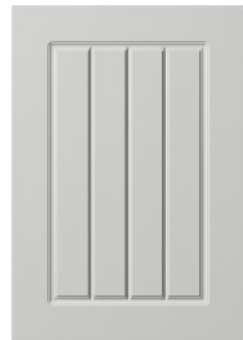

W021

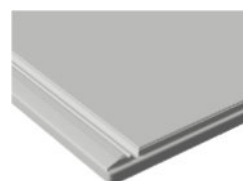

UN 3500

W022

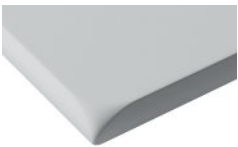

W023

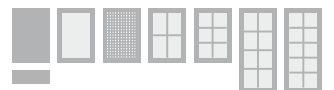



W024

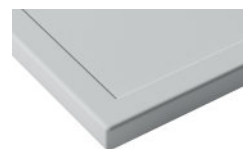
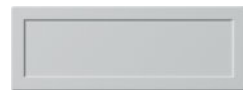

W025

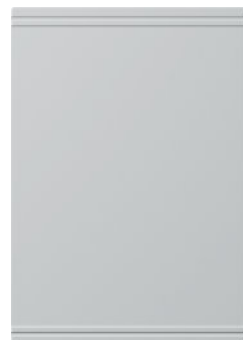

UN0137

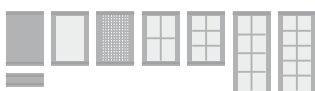

W026

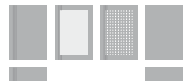
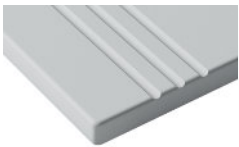

W027

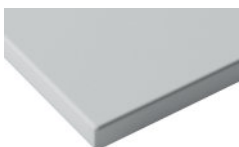

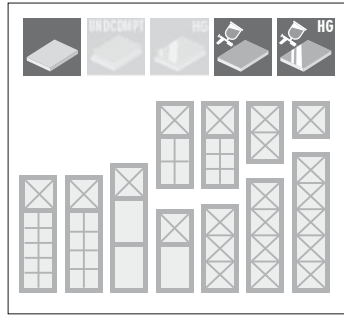
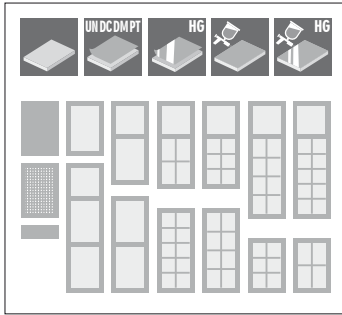

W028

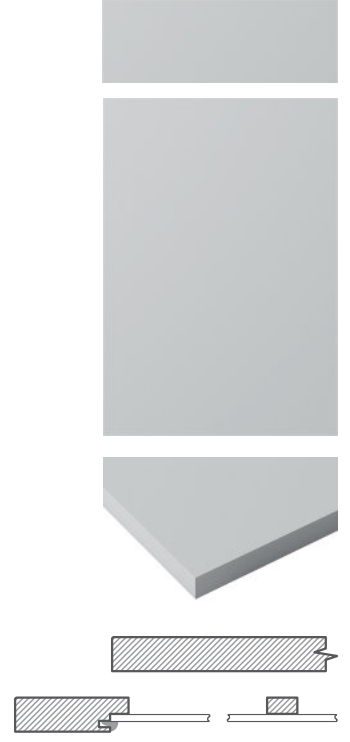

W029

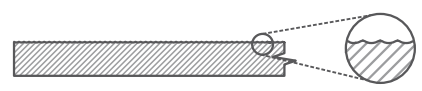
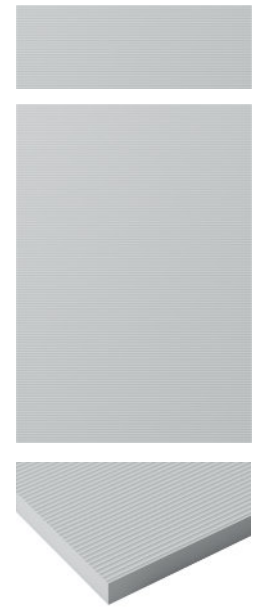

W030

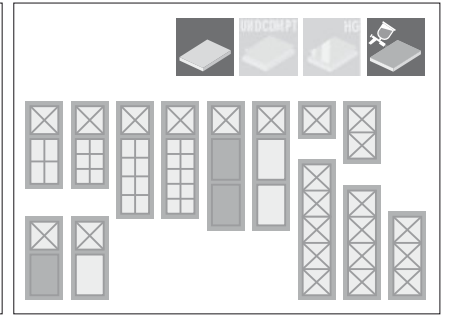
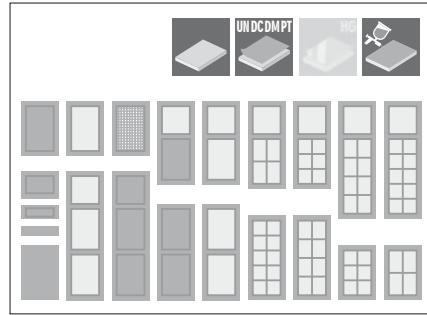
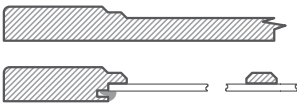
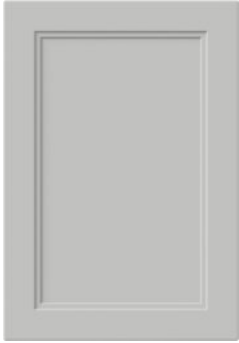
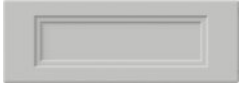

W031

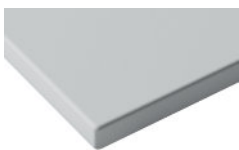



W032



W033

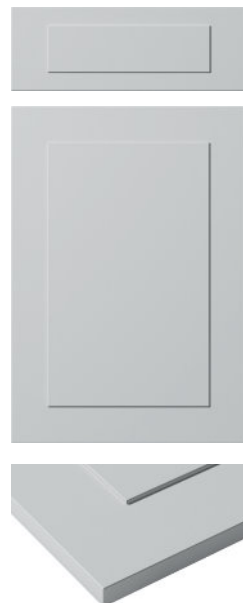

W034

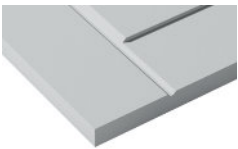

RAL 5010



W035

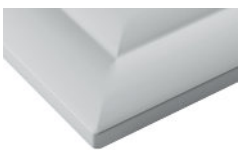

DM 2431





W036



W037



W038

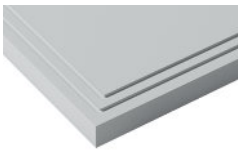

PT 5001



W039



RAL 7015





W040

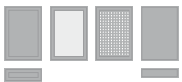
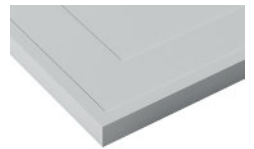
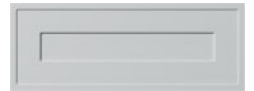

W050

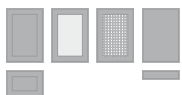
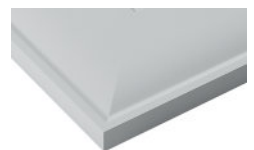

W052





W053

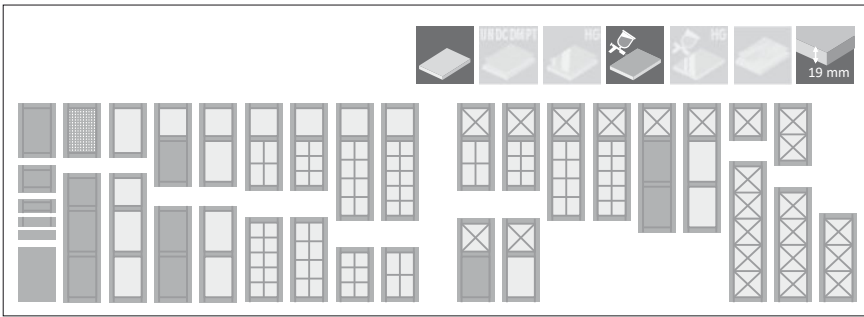

W055

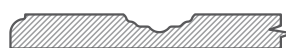

W056

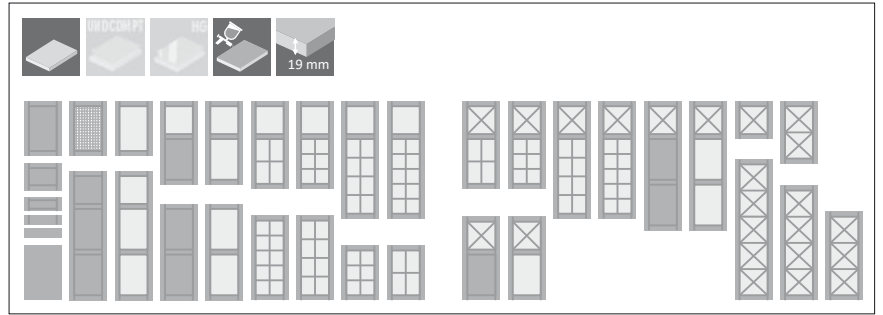
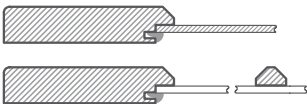
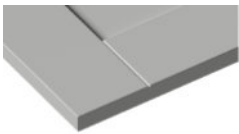

W057

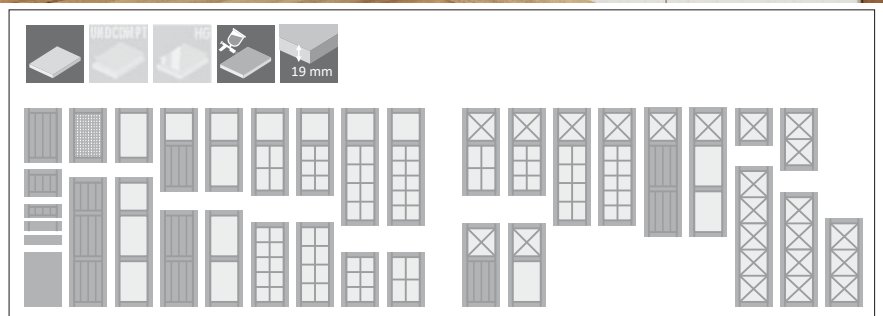
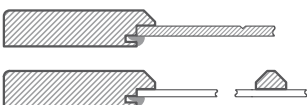
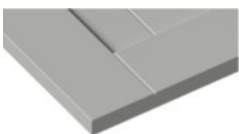



W058

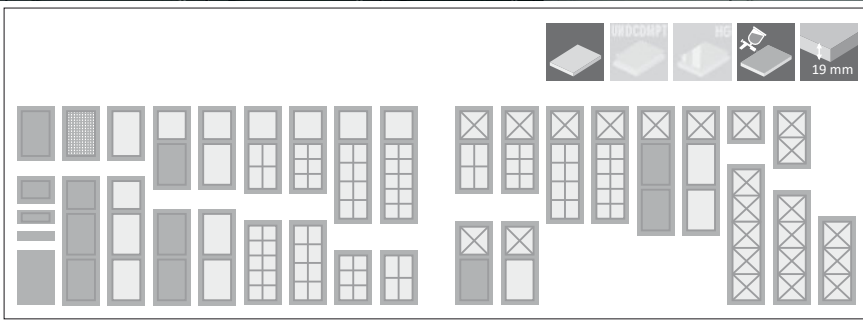
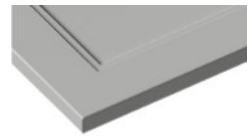

W059

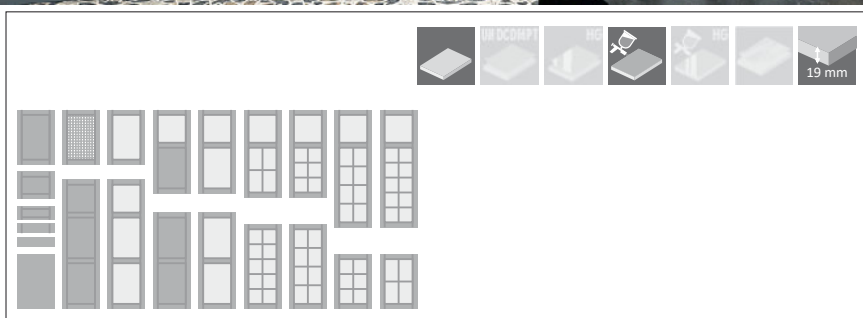
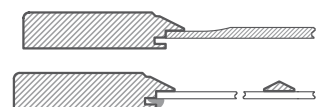
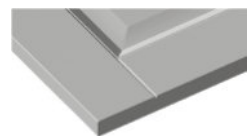
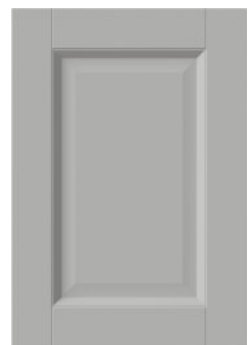

W061

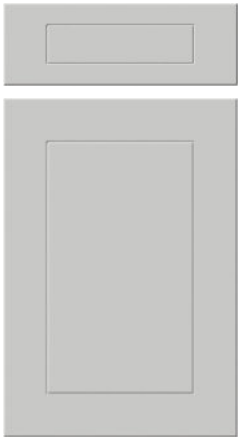

PT 5000



W062



PT 5008

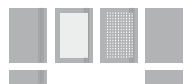



PT 5006

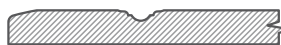

W063



PT 5000



W064





proform[®]

DESIGN QUALITY TECHNOLOGY

DVÍŘKA S ÚCHYTKAMI / DVIERKA S ÚCHYTKAMI / FRONTS WITH HANDLES



UAL-1

ELOX INOX LAK ÜCHYTKA ÜCHYTKA HANDLE

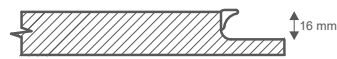

UAL-2

ELOX INOX LAK ÜCHYTKA ÜCHYTKA HANDLE

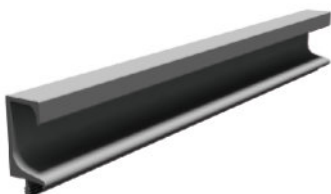

UAL-5

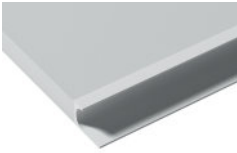

ŮCHYTKA
ŮCHYTKA
HANDLE

ELOX	INOX	LAK
------	------	-----

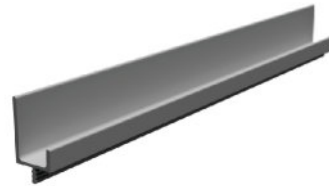
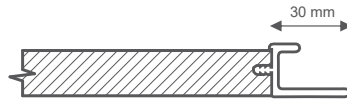

UAL-6

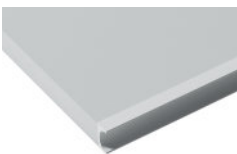

ŮCHYTKA
ŮCHYTKA
HANDLE

ELOX	INOX	LAK
------	------	-----

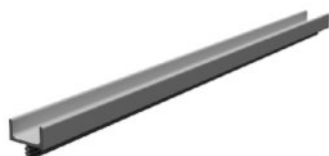

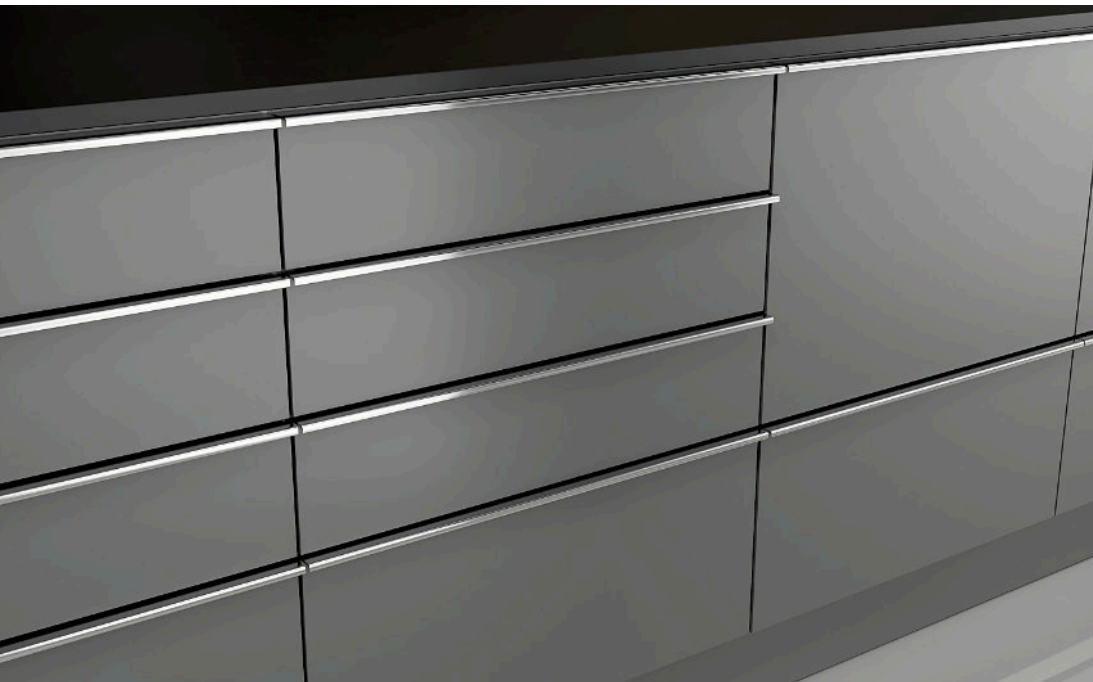

UAL-7



ELOX INOX LAK ÚCHYTKA ÚCHYTKA HANDLE

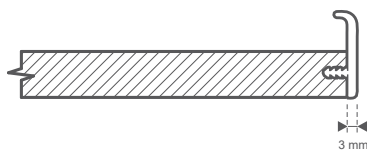

UAL-7

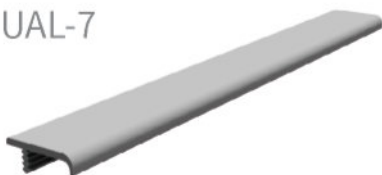

UAL-7/1



UAL-7/2



UAL-7/3



UAL-7/4



UAL-8



ÚCHYTKA
ÚCHYTKA
HANDLE

ELOX	INOX	LAK
------	------	-----

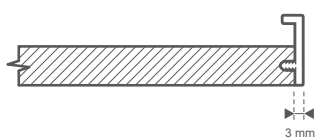

UAL-8

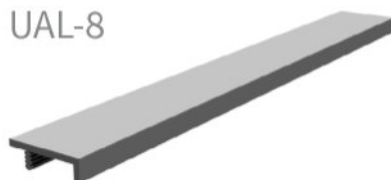

UAL-8/1

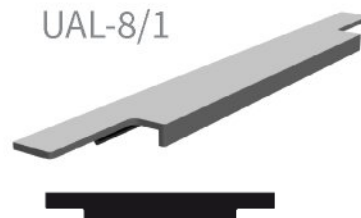

UAL-8/2

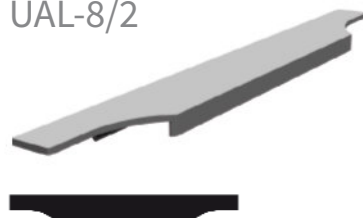

UAL-8/3

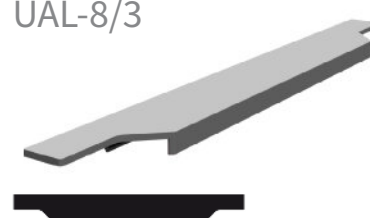

UAL-8/4

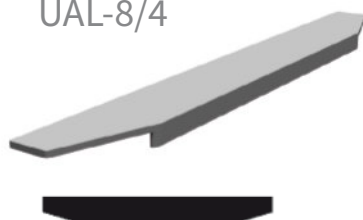

UAL-8/5

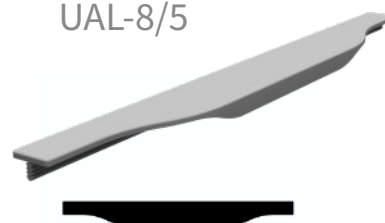



UAL-9



ELOX INOX LAK ÚCHYTKA ÚCHYTKA HANDLE

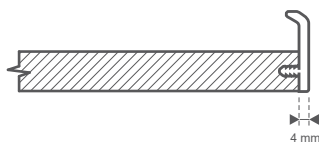

UAL-9

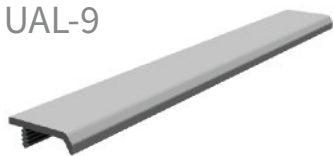

UAL-9/1



UAL-9/2



UAL-9/3



UAL-9/4





proform[®]

DESIGN QUALITY TECHNOLOGY

HLINÍKOVÉ RÁMEČKY / HLINÍKOVÉ RAMČEKY / ALUMINIUM FRAME



ELOX INOX LAK
RÁMEČEK
RAMČEK
FRAME

D080

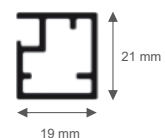

ELOX INOX LAK
RÁMEČEK
RAMČEK
FRAME

D845

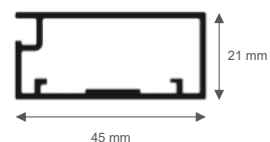

ELOX INOX LAK
RÁMEČEK
RAMČEK
FRAME

D935

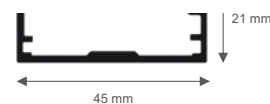
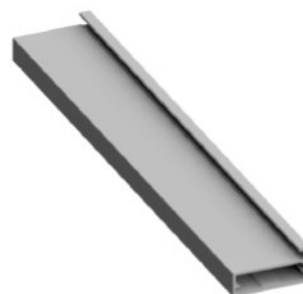



proform[®]

DESIGN QUALITY TECHNOLOGY

MASIVNÍ DVÍŘKA / MASIVNÉ DVIERKA / SOLID WOOD



M001

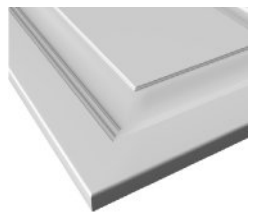
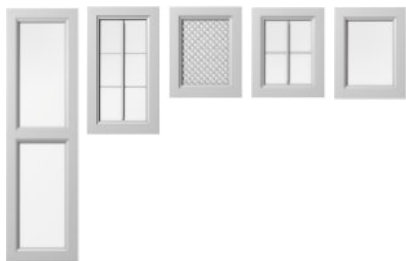

M002

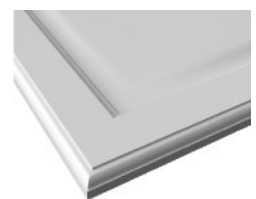
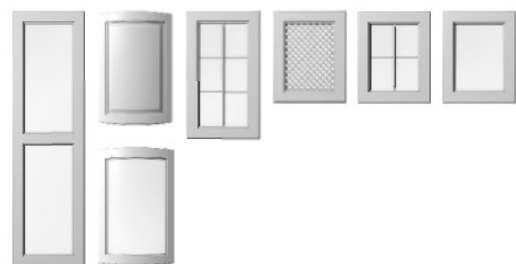

M003

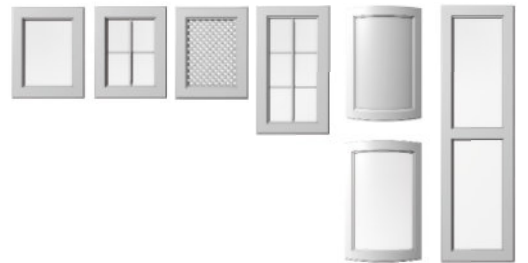
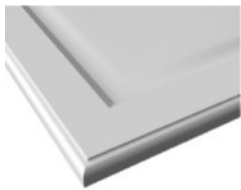

M004

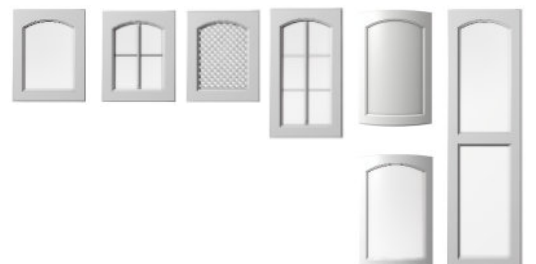
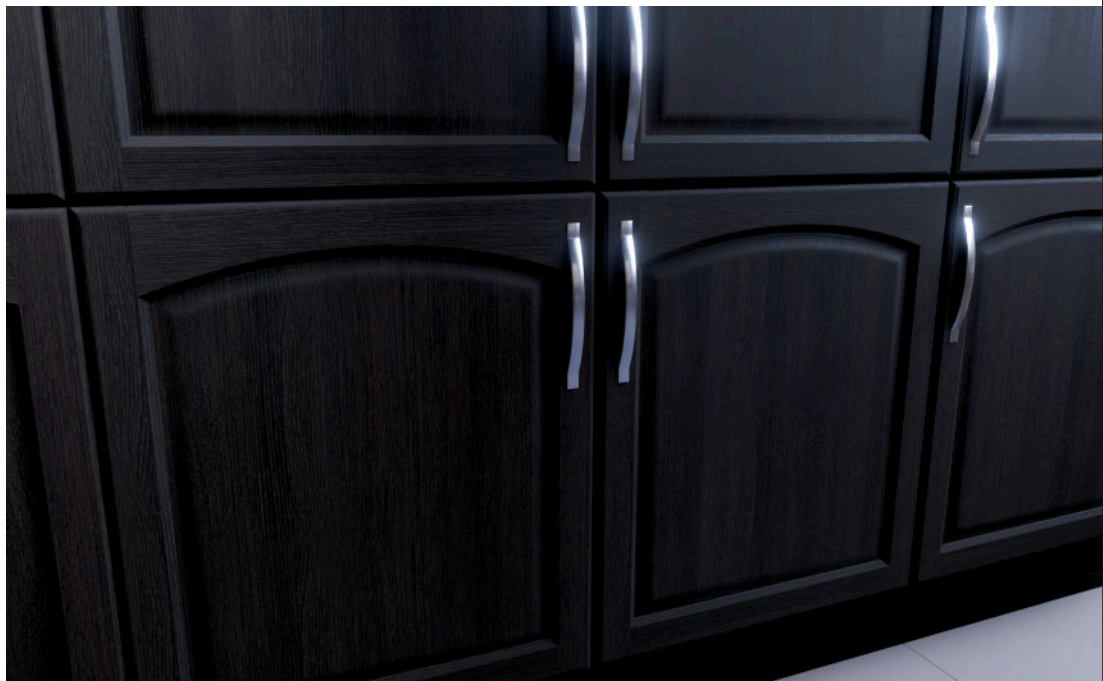
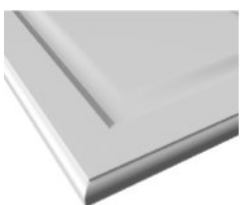



M005

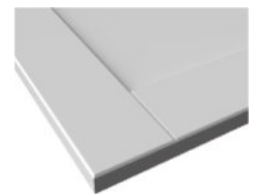

M006

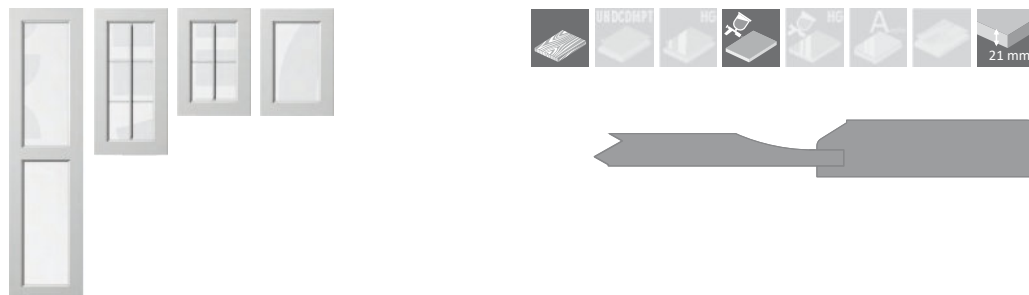
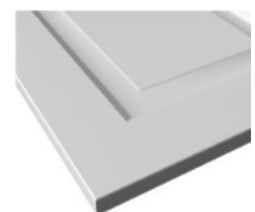



proform[®]

DESIGN QUALITY TECHNOLOGY

DÝHOVANÁ DVÍŘKA / DYHOVANÉ DVIERKA / VENEER FRONTS



D001

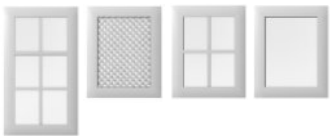

D002











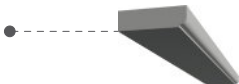



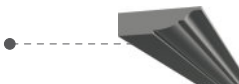

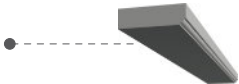

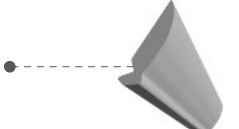
PŘÍSLUŠENSTVÍ / PRÍSLUŠENSTVO / ACCESSORIES

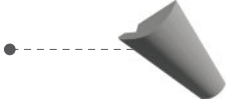
UKONČOVACÍ LIŠTY / UKONČOVACIE LIŠTY / DECORATIVE LATH

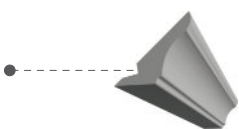
VERZE PRODUKTU
VERZIA PRODUKTU
VERSION OF PRODUCT

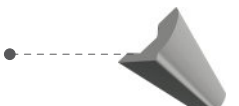
LIŠTA
LIŠTA
LATH

TYP PRODUKTU	ŘEZ	POPIS URČENÍ	DÉLKA	ŠÍŘKA	VÝŠKA	
TYP PRODUKTU	REZ	POPIS URČENIE	DÍŽKA	ŠÍRKA	VÝŠKA	
TYPE OF PRUDUCT	CROSS-SECTION	DESCRIPTION	LENGHT	WIDTH	HEIGHT	
LU1		UNIVERZÁLNÍ UNIVERZÁLNA UNIVERSAL	2440	65	19	
LU2		UNIVERZÁLNÍ UNIVERZÁLNA UNIVERSAL	2440	65	19	
LU3		NA HORNÍ SKŘÍŇKY NA HORNÉ SKRINKY UNDER-CUPBOARD	2440	70	19	
LU4		UNIVERZÁLNÍ UNIVERZÁLNA UNIVERSAL	2440	65	19	
LU5		NA HORNÍ SKŘÍŇKY NA HORNÉ SKRINKY UNDER-CUPBOARD	2440	80	18/65	
LU6		NA HORNÍ SKŘÍŇKY NA HORNÉ SKRINKY UNDER-CUPBOARD	2440	55	12/29	
LU7		NA HORNÍ SKŘÍŇKY NA HORNÉ SKRINKY UNDER-CUPBOARD	2440	92	25/60	
LU8		NA HORNÍ SKŘÍŇKY NA HORNÉ SKRINKY UNDER-CUPBOARD	2440	68	22/45	
LU9		NA HORNÍ SKŘÍŇKY NA HORNÉ SKRINKY UNDER-CUPBOARD	2440	78	16/39	

LU1 - LU9



OBKLADOVÉ SLOUPKY / OBKLADOVÉ STĹPIKY / PILASTERS

TYP PRODUKTU TYP PRODUKTU TYPE OF PRUDUCT	ŠÍŘKA ŠÍŘKA WIDTH
PRO1	50 mm
PRO2	50 mm
PRO3	50 mm
PRO4	50 mm
PRO5	50 mm
PRO6	50 mm

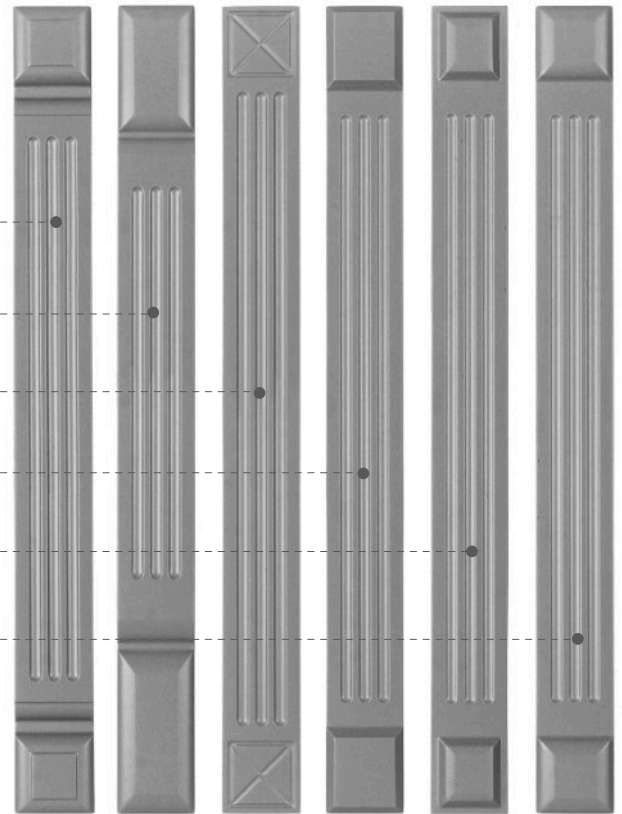

PRO1 - PRO6



UKONČOVACÍ LIŠTY / UKONČOVACIE LIŠTY / DECORATIVE LATH

VERZE PRODUKTU
VERZIA PRODUKTU
VERSION OF PRODUCT

TYP PRODUKTU TYP PRODUKTU TYPE OF PRUDUCT	SÍLA HRÚBKKA THICKNESS	VÝŠKA VÝŠKA HEIGHT	ŠÍŘKA ŠÍŘKA WIDTH
SZ	16 mm 18 mm 19 mm 21 mm	min. 120 mm	min. 120 mm
LB	16 mm 18 mm 19 mm 21 mm	min. 75 mm	min. 120 mm
KB	16 mm 18 mm 19 mm 21 mm	125 mm	
KC	16 mm 18 mm 19 mm 21 mm	154,5 mm	
KA	16 mm 18 mm 19 mm 21 mm	125 mm	

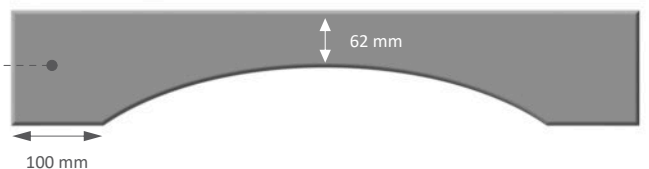
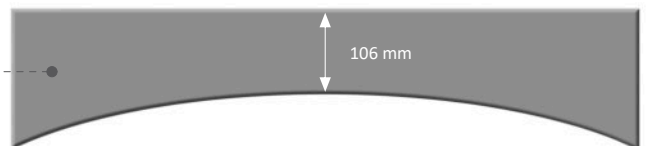
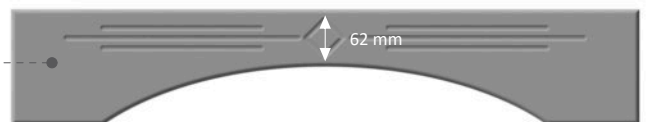
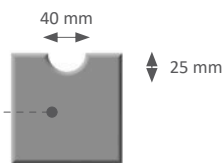



DESIGN QUALITY TECHNOLOGY

DEKORAČNÍ PANELE

CZ:

Dekorační panely Moduloform nabízejí širokou škálu možností jak zcela svobodně vytvořit jednotlivé části či celé místnosti. Ukázali jsme, že vzor je nejen vlastností určitého prvku, ale že může být také součástí větší formy, kde vzory spojují jednotlivé prvky do jedinečného celku. Naše panely Vám poskytují nepřehledné možnosti pro realizaci Vašich nápadů. Jsou určeny pro všechny kreativní profesionály, kteří se nebojí překonávat zažitá představy. Díky nám již jednotlivé prvky nejsou ploché a prostor získává na hloubce.

Panely nabízíme v průhledné a plně verzi a povrchových úpravách fólie, lak a dýha.

DEKORAČNÉ PANELE

SK:

Dekoračné panely Moduloform ponúkajú širokú škálu možností ako úplne slobodne vytvoriť jednotlivé časti či celé miestnosti. Ukázali sme, že vzor je nielen vlastnosťou určitého prvku, ale že môže byť tiež začiatkom väčšej formy, kde vzory spájajú jednotlivé prvky do jedinečného celku. Naše panely Vám poskytujú nespočetné možnosti pre realizáciu všetkých Vašich nápadov. Sú určené pre všetkých kreatívnych profesionálov, ktorí sa neboja prekonávať zaužívané predstavy. Vďaka nám už jednotlivé prvky nie sú ploché a priestor získava na hĺbke.

Panely ponúkame v priehľadnej a plnej verzii a povrchových úpravách fólia, lak a dýha.

DECORATIVE PANEL

EN:

ModuloForm presents a vast range of possibilities and choices of design creations for individual elements or whole surfaces. We prove that design is not a feature of just one element but a start of a larger form, and that it is the design that joins individual elements into one, unique whole. Our panels are, on one hand, an unlimited source of ready ideas for various applications, and on the other hand, a resource for anybody interested in creativity, willing to break the mould and push the boundaries of their imagination. With us, a single element is no longer flat and surfaces acquire depth. Available in full and openwork versions, available finishing: foil, lacquer and veneer.





PD1
VÍCE VARIANT PROVEDENÍ

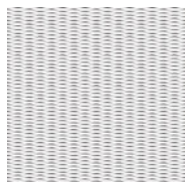

PD2
VÍCE VARIANT PROVEDENÍ



PD3
VÍCE VARIANT PROVEDENÍ



PD4
VÍCE VARIANT PROVEDENÍ



PD5
VÍCE VARIANT PROVEDENÍ

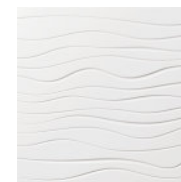

PD6



PD7
VÍCE VARIANT PROVEDENÍ



PD8



PD9



PD10/1



PD11



PD12/1



PD13



PD14

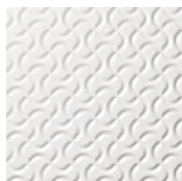

PD15

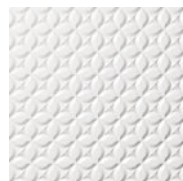

PD16



PD17



PD18

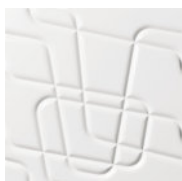

PD19
VÍCE VARIANT PROVEDENÍ



PD20



PD21

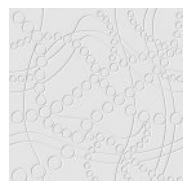

PD22/1



PD23



PD24

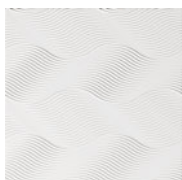

PD25



PD26

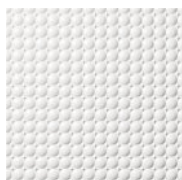

PD27

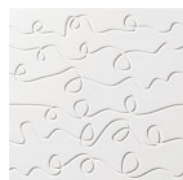

PD28



PD29



PD30



PD31



PD32



PD33



PD34 (N06) **NEW!**

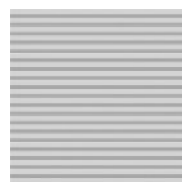

PD35 (N08) **NEW!**



PD36 (N09) **NEW!**



PD37 (N10) **NEW!**



PD38 (N17) **NEW!**

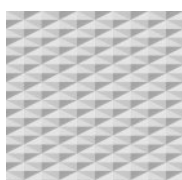

PD39 (N19) **NEW!**

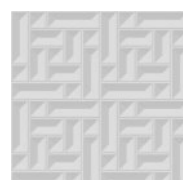

PD40 (N21) **NEW!**



PD41 (N22) **NEW!**



PD42 (N25) **NEW!**

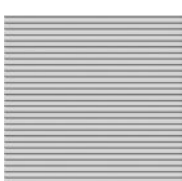

PD43 (N32) **NEW!**



PD44 (N31) **NEW!**

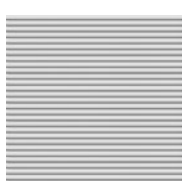

PD45 (N05) **NEW!**



PD46 (N01) **NEW!**

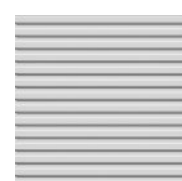

PD47 (N02) **NEW!**



PD48 (N33) **NEW!**

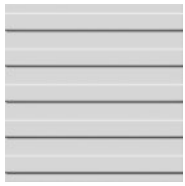

PD49 (N11) **NEW!**

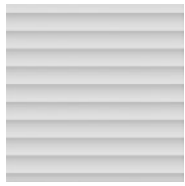

PD50 (N13) **NEW!**

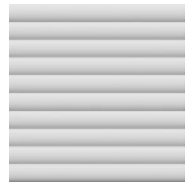

PD51 (N14) **NEW!**



PD52 (N16) **NEW!**

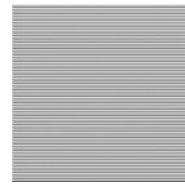

PD53 (N07) **NEW!**



PDA23, W038



PDA1



PDA1F

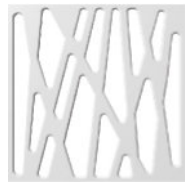

PDA2



PDA2F

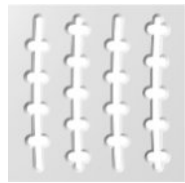

PDA3



PDA3F

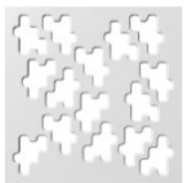

PDA4



PDA4F



PDA5



PDA5F



PDA6



PDA6F



PDA7



PDA7F

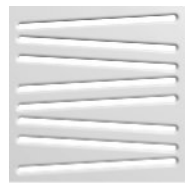

PDA8



PDA8F



PDA9



PDA9F



PDA10



PDA10F

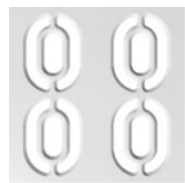

PDA11



PDA11F

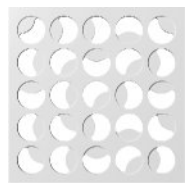

PDA12



PDA12F

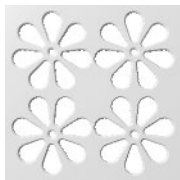

PDA13



PDA13F

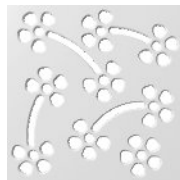

PDA14



PDA14F

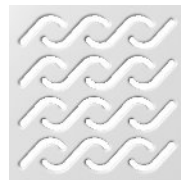

PDA15



PDA15F



PDA16



PDA16F

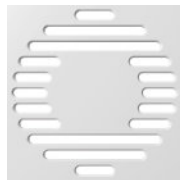

PDA17



PDA17F

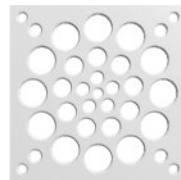

PDA18



PDA18F

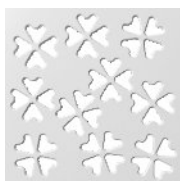

PDA19



PDA19F

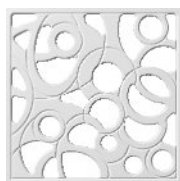

PDA20



PDA20F

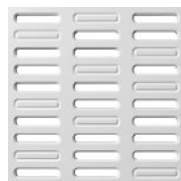

PDA21



PDA21F

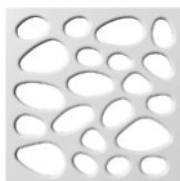

PDA22



PDA22F



PDA23



PDA23F



PDA24



PDA24F



PDA25



PDA25F

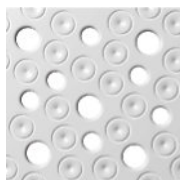

PDA26



PDA26F

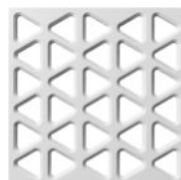

PDA27



PDA27F



PDA28

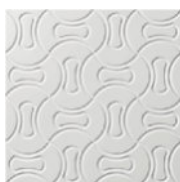

PDA28F



PDA29

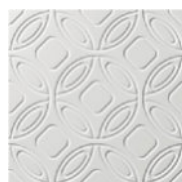

PDA29F



PDA30



PDA30F

PD1/1



L1 (180 mm)

L2 (300 mm)

L4 (600 mm)



NCS S 5020



PD2

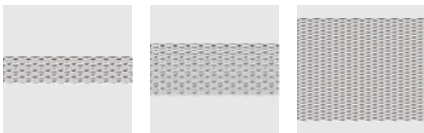
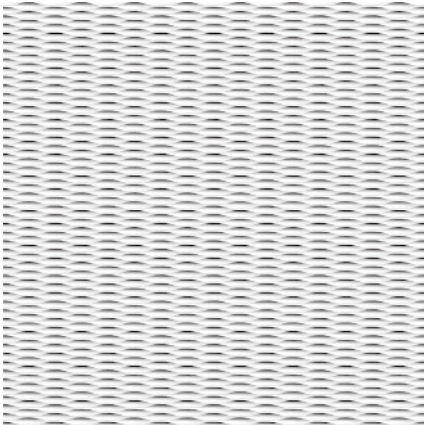

L1 (170 mm)

L2 (320 mm)

L4 (600 mm)



UN 0111



PD3



DC 2262

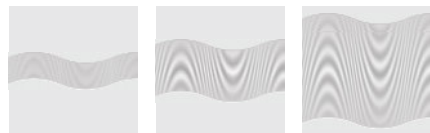
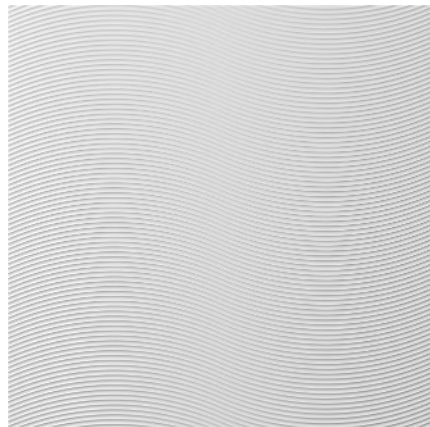

L1 (220 mm) L2 (370 mm) L4 (670 mm)



PD4

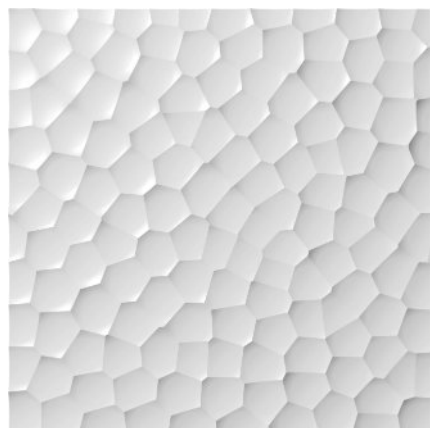

L1 (220 mm) L2 (380 mm) L4 (720 mm)

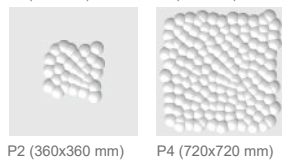

P2 (360x360 mm) P4 (720x720 mm)



PD5



L1 (210 mm)

L2 (360 mm)

L4 (600 mm)



PD6



L1 (160 mm)

L2 (320 mm)

L4 (600 mm)



MDF BLACK + DM 2495





PD7

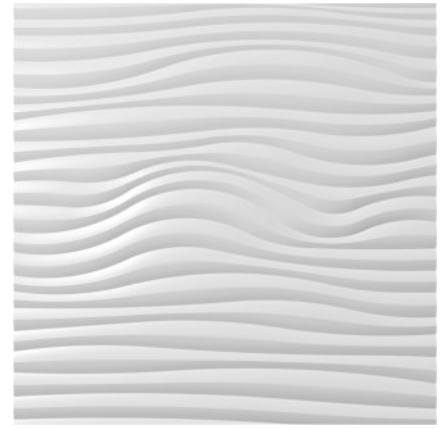

L1 (210 mm) L2 (350 mm) L4 (600 mm)

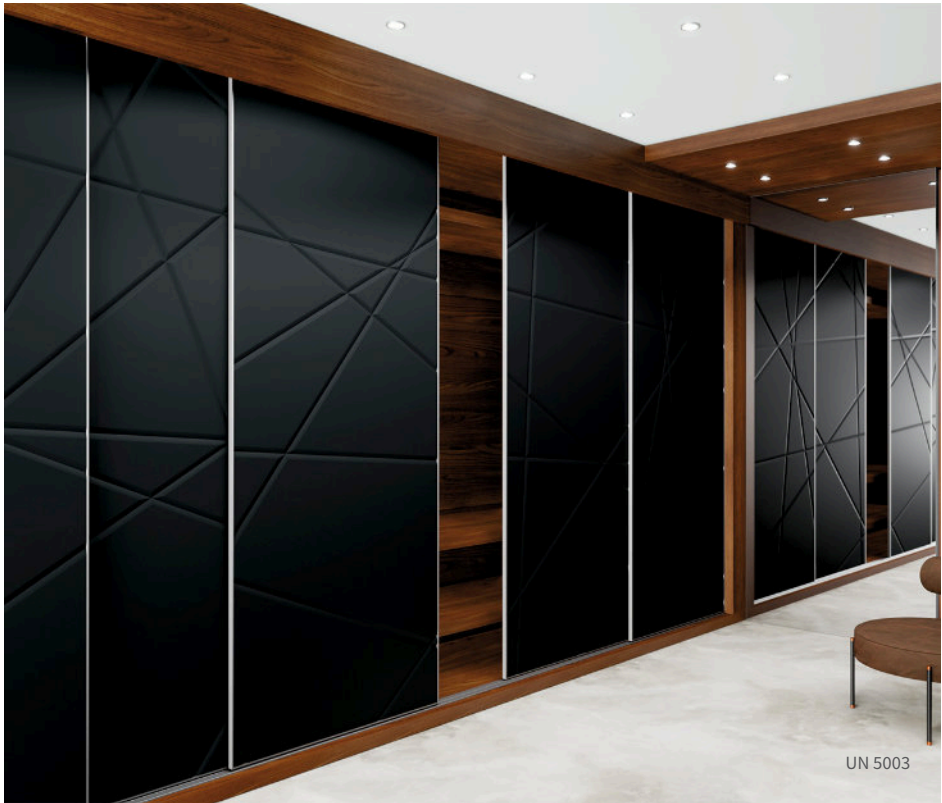

PD8

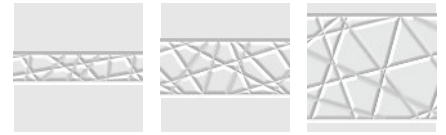

L1 (190 mm) L2 (340 mm) L4 (640 mm)

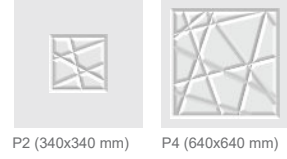

P2 (340x340 mm) P4 (640x640 mm)

PD9

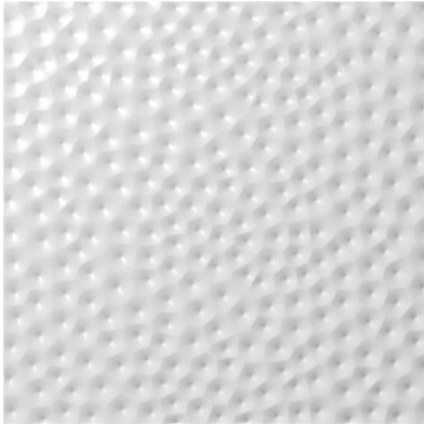

L1 (210 mm)

L2 (360 mm)

L4 (660 mm)



P2 (360x360 mm)

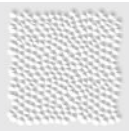

P4 (660x660 mm)



UN 2065



PD10/1



L4 (600 mm)



P3 (350x950 mm)



UN 3500





DM 2499



PD11

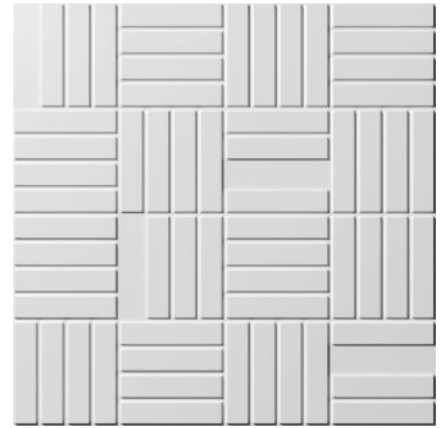

L1 (160 mm) L2 (310 mm) L4 (610 mm)

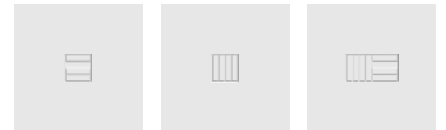

P1/1 (160x160 mm) P1/2 (160x160 mm) P1/3 (310x160 mm)



P2 (310x310 mm) P4 (610x610 mm)



NCS S 1030



PD12/1

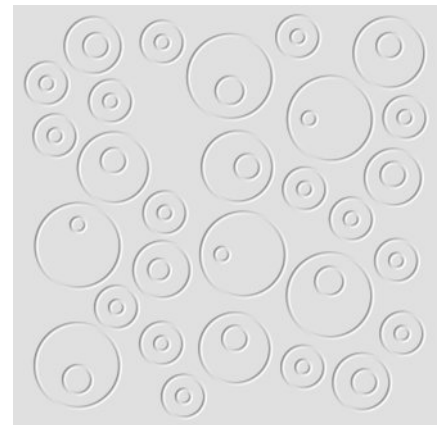

L2 (350 mm) L4, P4 (600x600 mm)

PD13

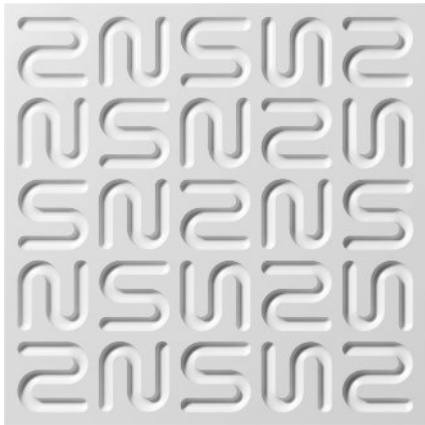

L1/1 (120 mm)



L1/2 (240 mm)



L2 (360 mm)



P1 (240x240 mm)



P2 (360x360 mm)



L4, P4 (600x600 mm)



424-2543



PD14

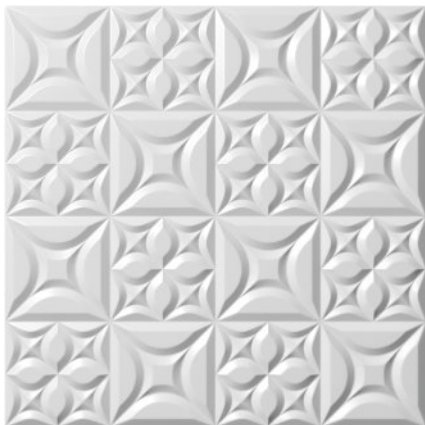

L1 (180 mm)



L2 (330 mm)



L3 (480 mm)



L4 (630 mm)



P1 (330x180 mm)

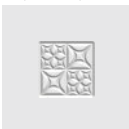

P2 (330x330 mm)

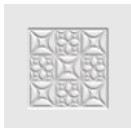

P3 (480x480 mm)



P4 (630x630 mm)



HG 2800



PD15



L1 (226 mm) L2 (376 mm) L4 (676 mm)

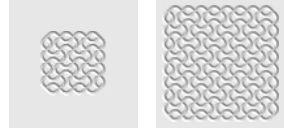

P2 (376x376 mm) P4 (676x676 mm)



PD16

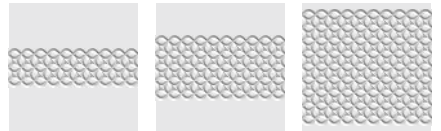
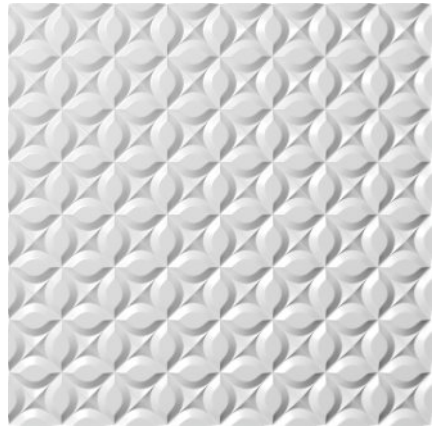

L1 (226 mm) L2 (376 mm) L4 (676 mm)

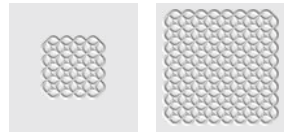

P2 (376x376 mm) P4 (676x676 mm)



PD17

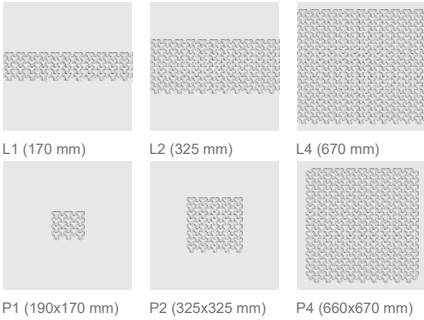

PD18

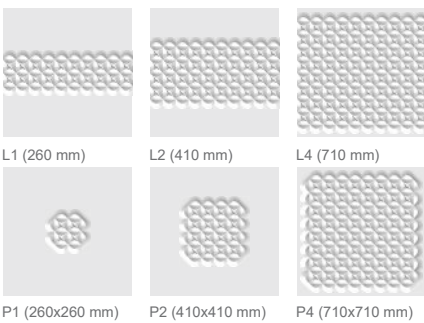
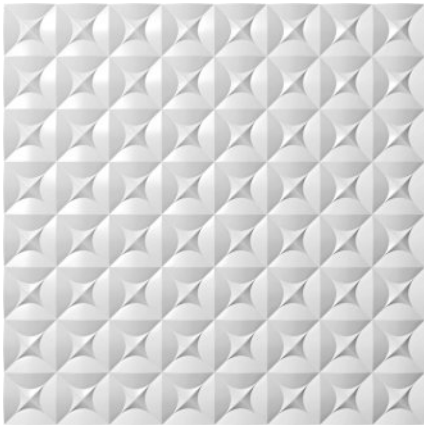

PD19/1



PD20

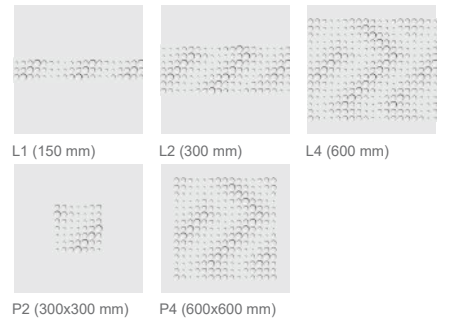
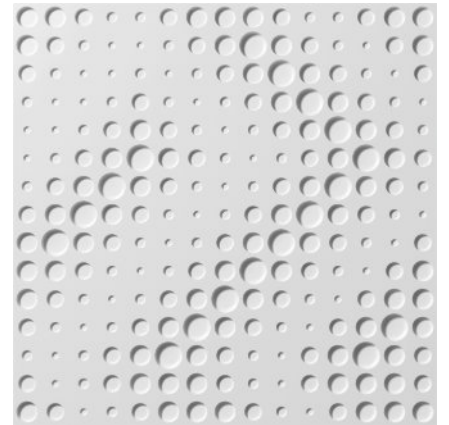

PD21



L2 (360 mm)

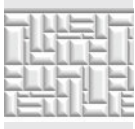

L4 (660 mm)



P2 (360x360 mm)

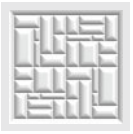

P4 (660x660 mm)



PD22/1



L1 (160 mm)



L2 (300 mm)



P2 (300x300 mm)





PT 5006



- L1 (180 mm) L2 (360 mm) L4 (600 mm)
- P1/1 (285x90 mm) P1/2 (367x90 mm) P1/3 (295x90 mm)
- P1/4 (600x90 mm) P1/5 (360x90 mm) P1/6 (404x90 mm)
- P1/7 (400x90 mm) P4 (600x600 mm)



UN 2065



- L2 (350 mm) L3 (450 mm) P2/1 (320x340 mm)
- P2/2 (340x370 mm) P3 (490x510 mm)

PD25

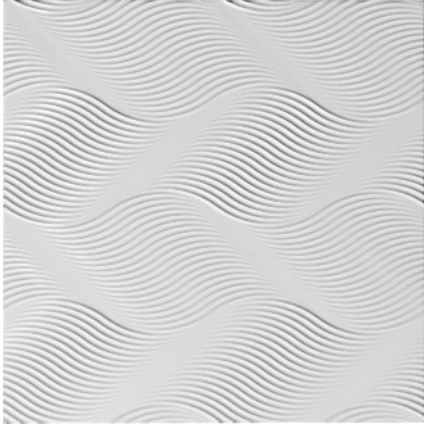

L1 (220 mm)

L2 (370 mm)

L4 (680 mm)



PD26



L2 (280 mm)

L3 (420 mm)



P1 (180x210 mm)



PD27



UN 5004

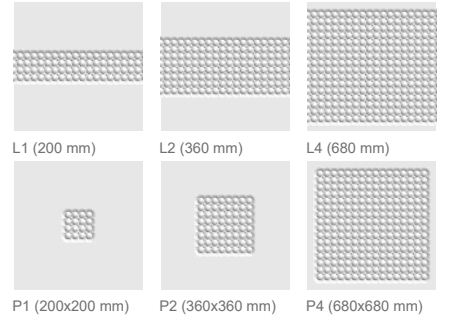
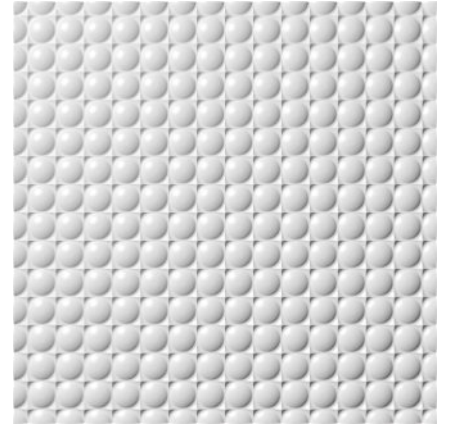

PD28



UN 3500

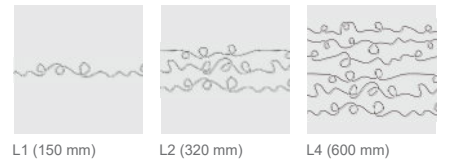
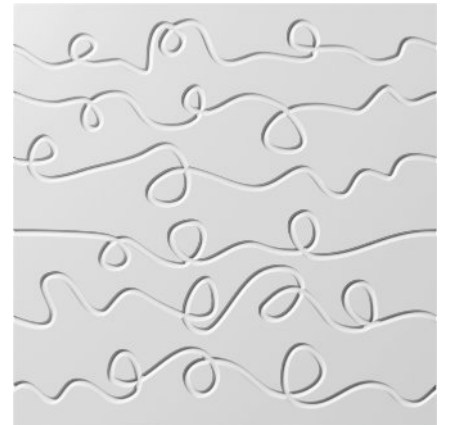

PD29

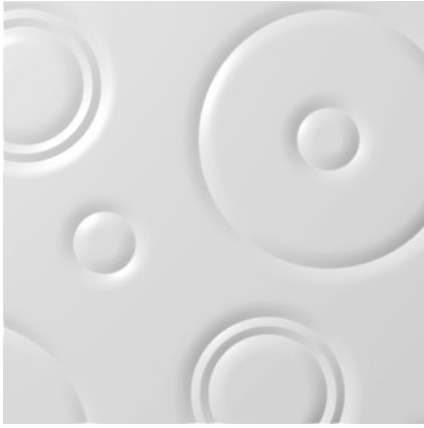

P1 (220x220 mm) P2 (310x310 mm)



UN 2065



PD30



L3 (560 mm) P2 (380x410 mm)



PT 5001



PD31



DM 2494



L1 (163 mm)

L2 (310 mm)

L3 (457 mm)

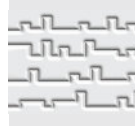

L4 (600 mm)



PD32



PT 5006

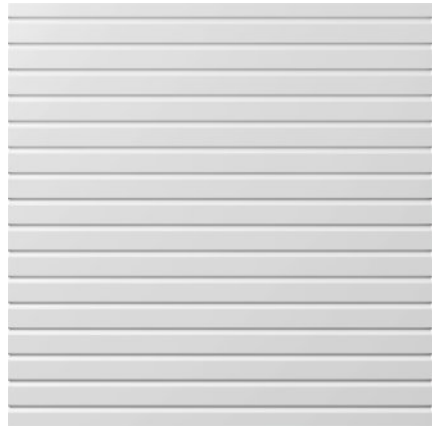

L1 (150 mm)

L2 (300 mm)

L4 (600 mm)



PD33

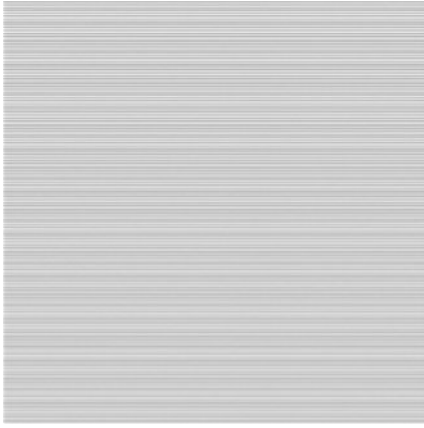

L1/1 (60 mm)

L1/2 (120 mm)

L2 (300 mm)



DM 2499



A

AB

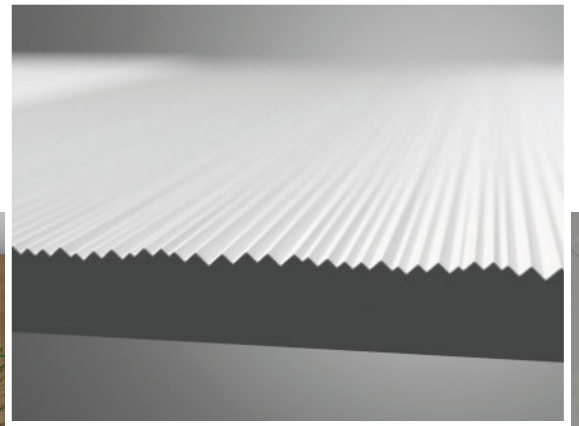

DM 2499



proform[®]

DESIGN QUALITY TECHNOLOGY

NOVÉ DEKORAČNÍ PANELE
NOVÉ DEKORAČNÉ PANELE
NEW PD DECORATIVE PANELS

PD34 (N06)

NEW!

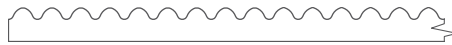
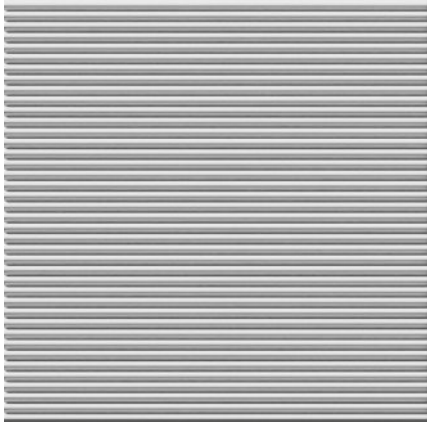

PD35 (N08)

NEW!

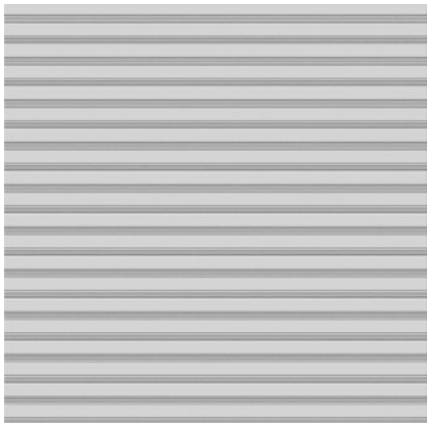

NEW!

PD36 (N09)

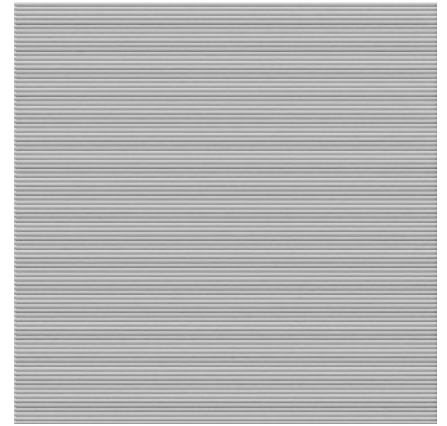

NEW!

PD37 (N10)

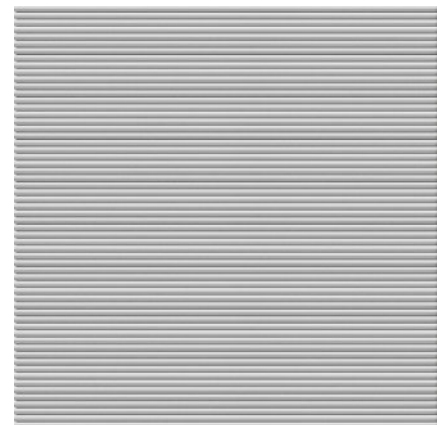

PD38 (N17)

NEW!

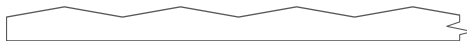

PD39 (N19)

NEW!

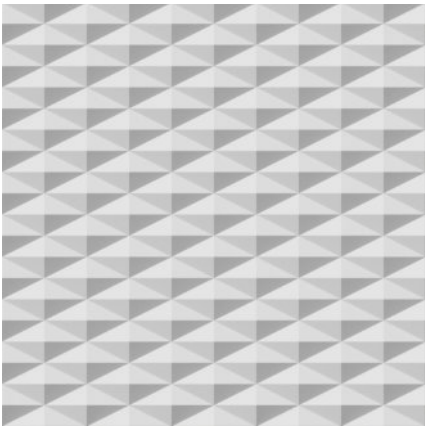

NEW!

PD40 (N21)

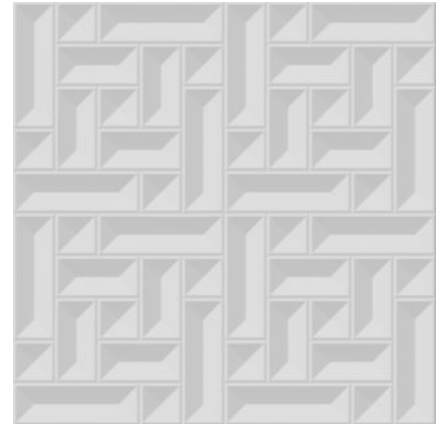

NEW!

PD41 (N22)

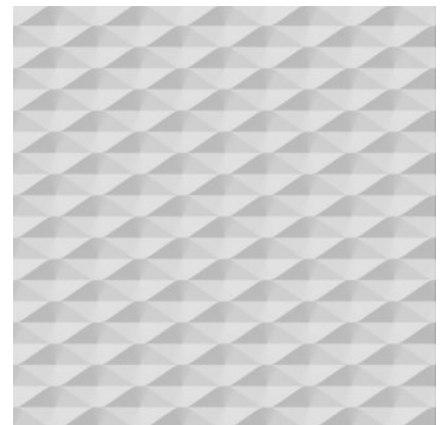

PD42 (N25)

NEW!

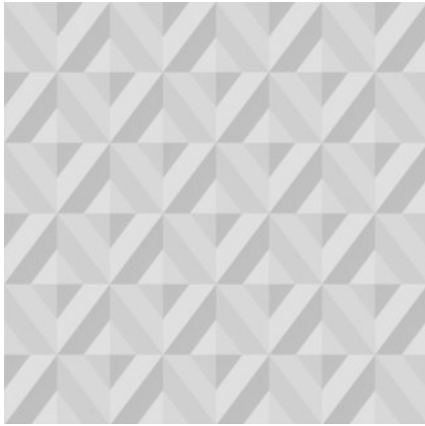

PD43 (N32)

NEW!

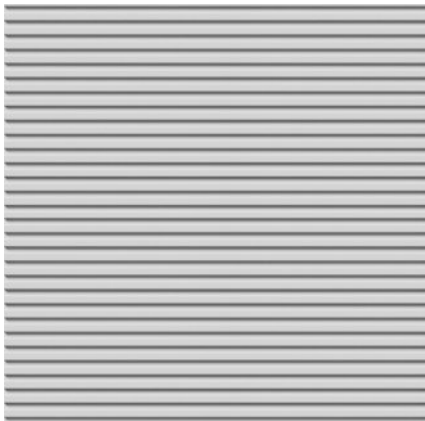

NEW!

PD44 (N31)



NEW!

PD45 (N05)

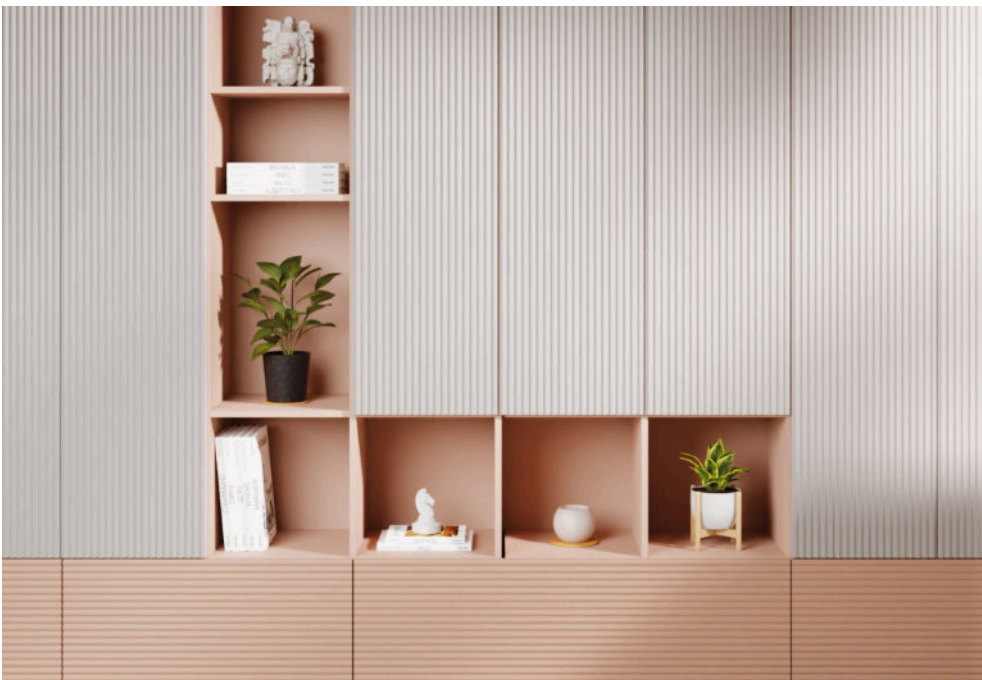

PD46 (N01)

NEW!

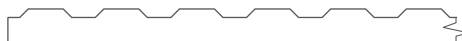
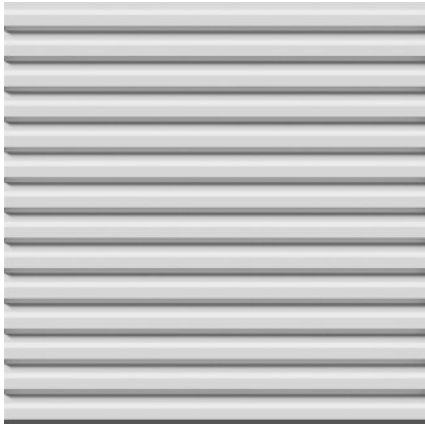

PD47 (N02)

NEW!

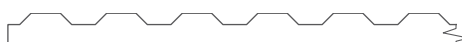

NEW! PD48 (N33)



NEW! PD49 (N11)

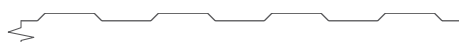

PD50 (N13)

NEW!



PD51 (N14)

NEW!



NEW!

PD52 (N16)



NEW!

PD53 (N07)

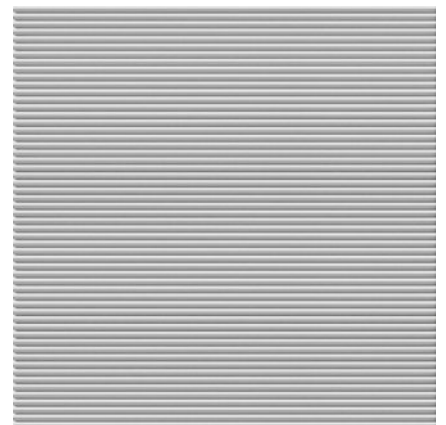

PDA1

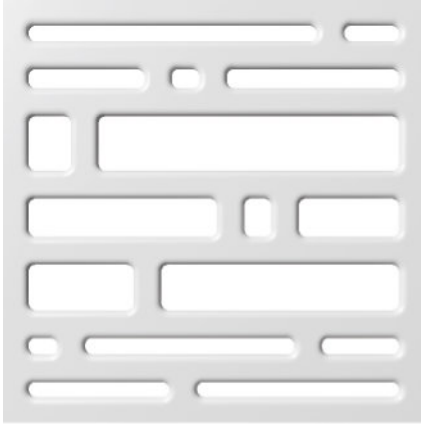

P2/1 (300x300 mm) P2/2 (600x155 mm) P3 (600x355 mm)



P4 (600x600 mm)



NCS S 5005



LAK LAK LACQUER AA 19, 22 mm

PDA1F



P2/1F (300x300 mm) P2/2F (600x155 mm) P3F (600x355 mm)



P4F (600x600 mm)



UN 0116





LAK
LAK
LACQUER AA
19, 22 mm

PDA2

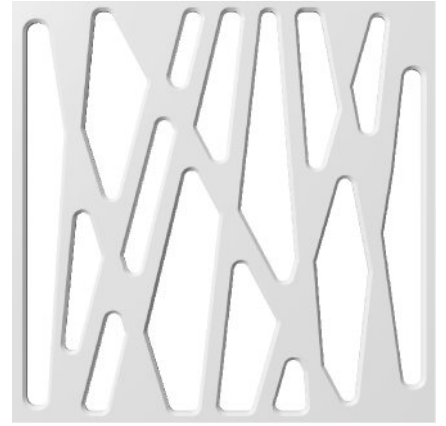

P2 (300x300 mm) P3 (290x600 mm) P4 (600x600 mm)



PDA2F



P2F (300x300 mm) P3F (290x600 mm) P4F (600x600 mm)

PDA3

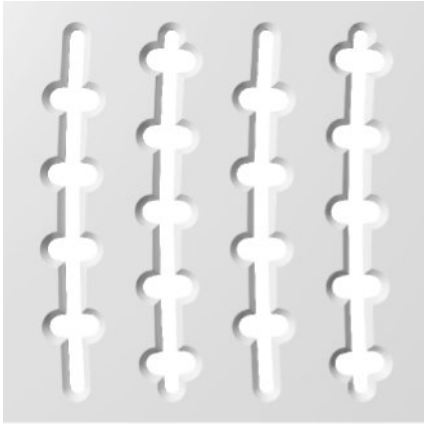

P2/1 (300x300 mm) P2/2 (133x600 mm) P3 (270x600 mm)



P4 (600x600 mm)



NCS S-0502-R



LAK
LAK
LACQUER
AA
19, 22 mm

PDA3F



P2/1F (300x300 mm) P2/2F (133x600 mm) P3F (270x600 mm)



P4F (600x600 mm)



UN 0111





UN 2065



LAK
LAK
LACQUER AA
19, 22 mm

PDA4

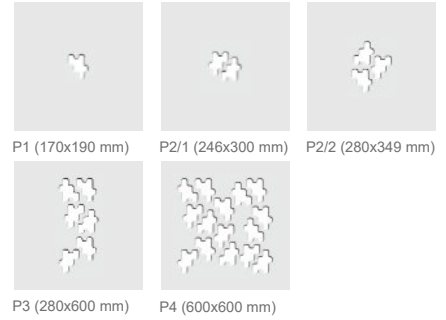
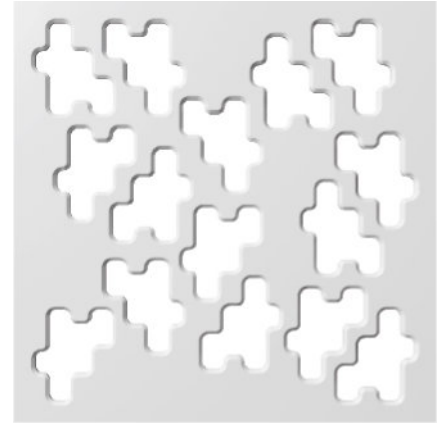

P1 (170x190 mm) P2/1 (246x300 mm) P2/2 (280x349 mm)
P3 (280x600 mm) P4 (600x600 mm)



PT 5001



PDA4F

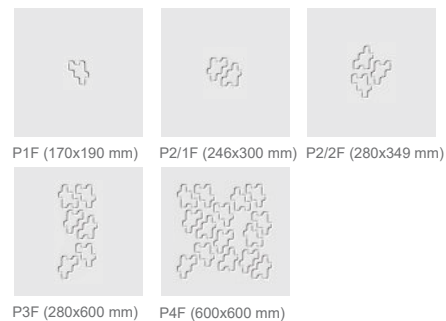

P1F (170x190 mm) P2/1F (246x300 mm) P2/2F (280x349 mm)
P3F (280x600 mm) P4F (600x600 mm)

PDA5



P2/1 (300x300 mm) P2/2 (100x600 mm) P3 (180x600 mm)



P4 (600x600 mm)



HG 0901



LAK
LAK
LACQUER AA
19, 22 mm

PDA5F



P2/1F (300x300 mm) P2/2F (100x600 mm) P3F (180x600 mm)



P4F (600x600 mm)



HG 9700





UN 5003



LAK
LAK
LACQUER AA
19, 22 mm

PDA6

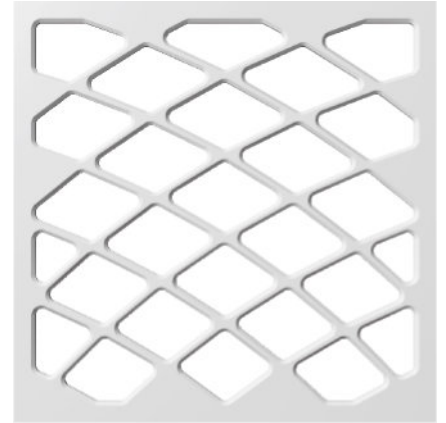

P2/1 (300x300 mm) P2/2 (390x277 mm) P3/1 (600x390 mm)



P3/2 (600x288 mm) P3/3 (600x402 mm) P4 (600x600 mm)

PDA6F



PT 5001



P2/1F (300x300 mm) P2/2F (390x277 mm) P3/1F (600x390 mm)



P3/2F (600x288 mm) P3/3F (600x402 mm) P4F (600x600 mm)

PDA7

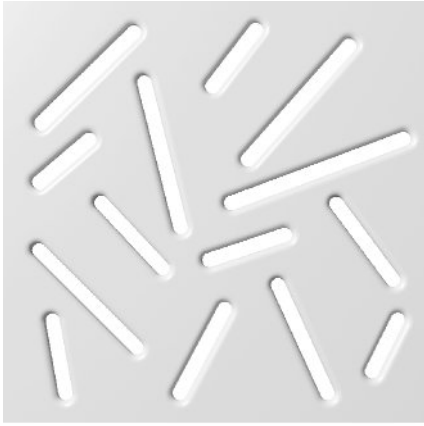

P2 (300x300 mm)



P4 (600x600 mm)



NCS S 3020



LAK
LAK
LACQUER AA
19, 22 mm

PDA7F



P2F (300x300 mm)



P4F (600x600 mm)



HG 0335



PDA8



RAL 9007



LAK LAK LACQUER AA 19, 22 mm

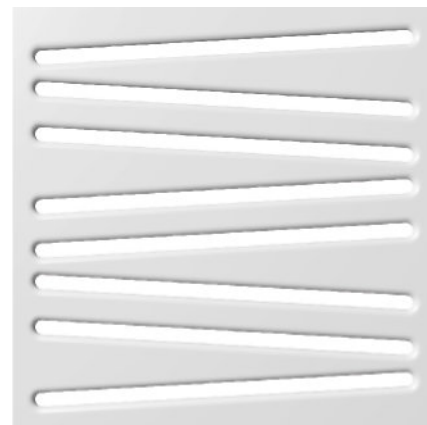

P2/1 (300x300 mm) P2/2 (600x110 mm) P3 (600x252 mm)



P4 (600x600 mm)

PDA8F



RAL 8016



P2/1F (300x300 mm) P2/2F (600x110 mm) P3F (600x252 mm)



P4F (600x600 mm)

PDA9

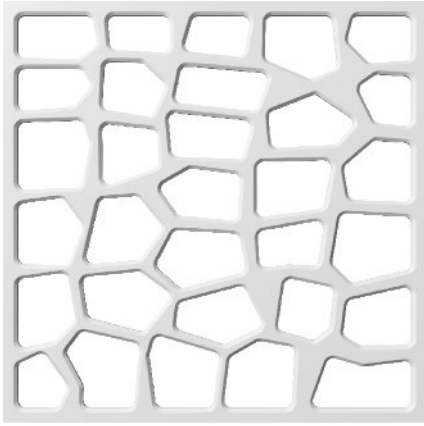

P2 (300x300 mm)

P3/1 (425x395 mm)

P3/2 (600x277 mm)



P3/3 (600x403 mm)

P4 (600x600 mm)



DM 2488



LAK LAK LACQUER AA 19, 22 mm

PDA9F



P2F (300x300 mm)

P3/1F (425x395 mm)

P3/2F (600x277 mm)



P3/3F (600x403 mm)

P4F (600x600 mm)



UN 5003



PDA10



RAL 9003 (PT 5001)



P2 (300x300 mm)



P4 (600x600 mm)



LAK LAK LACQUER AA 19, 22 mm

PDA10F



PT 5001



P2F (300x300 mm)



P4F (600x600 mm)



PDA11

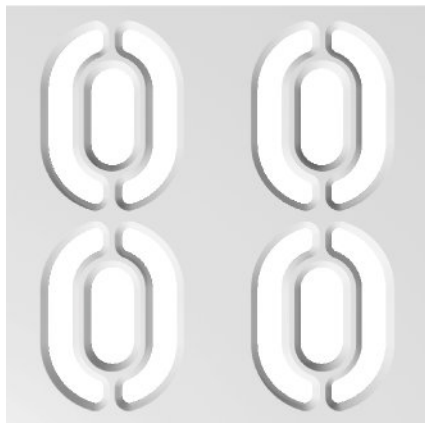

P2 (300x315 mm) P3 (300x600 mm) P4 (600x600 mm)



RAL 5003



LAK LAK LACQUER AA 19, 22 mm

PDA11F



P2F (300x315 mm) P3F (300x600 mm) P4F (600x600 mm)



UN 1001



PDA12



LAK
LAK
LACQUER AA
19, 22 mm

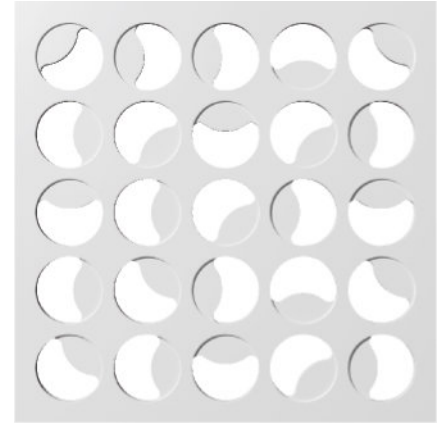

P2/1 (260x260 mm) P2/2 (600x156 mm) P3/1 (378x378 mm)

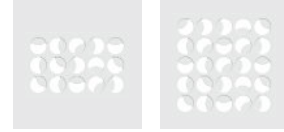

P3/2 (600x378 mm) P4 (600x600 mm)

PDA12F



P2/1F (260x260 mm) P2/2F (600x156 mm) P3/1F (378x378 mm)



P3/2F (600x378 mm) P4F (600x600 mm)

PDA13

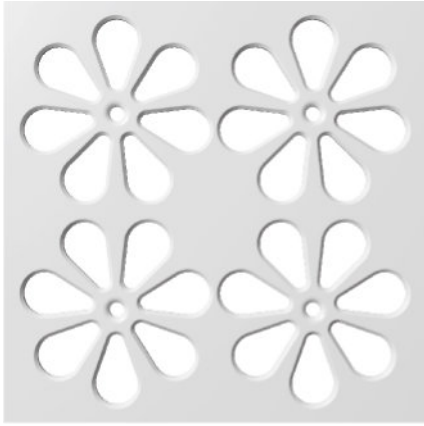

P2 (300x300 mm) P3 (300x600 mm) P4 (600x600 mm)



HG 7015



LAK LAK LACQUER AA 19, 22 mm

PDA13F



P2F (300x300 mm) P3F (300x600 mm) P4F (600x600 mm)



UN 0111



PDA14

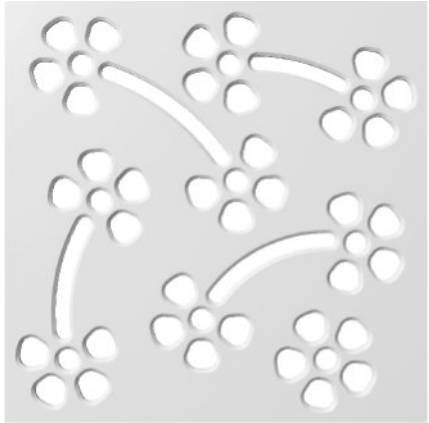
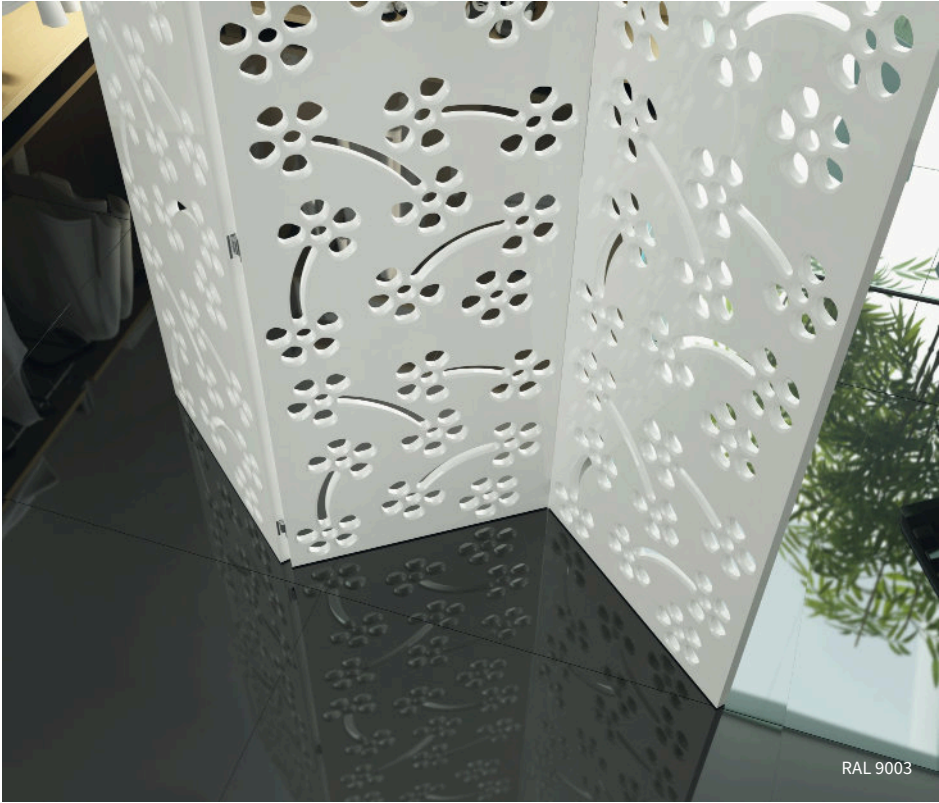

P2 (300x300 mm)



P4 (600x600 mm)



LAK
LAK
LACQUER AA
19, 22 mm

PDA14F



P2F (300x300 mm)



P4F (600x600 mm)



PDA15

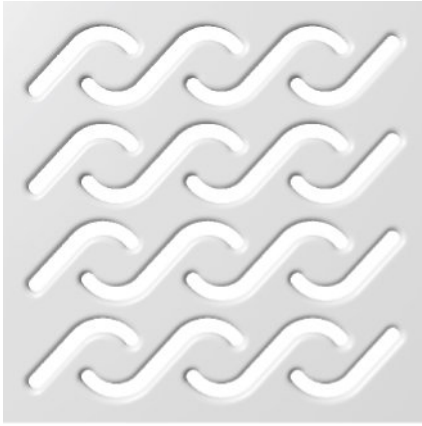

P2/1 (300x300 mm) P2/2 (600x185 mm) P3 (600x330 mm)



P4 (600x600 mm)



LAK
LAK
LACQUER
AA
19, 22 mm

PDA15F

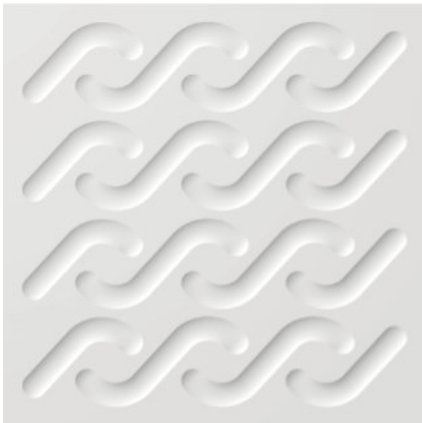

P2/1F (300x300 mm) P2/2F (600x185 mm) P3F (600x330 mm)



P4F (600x600 mm)



PT 5001

PDA16



HG 8810



LAK LAK LACQUER AA 19, 22 mm

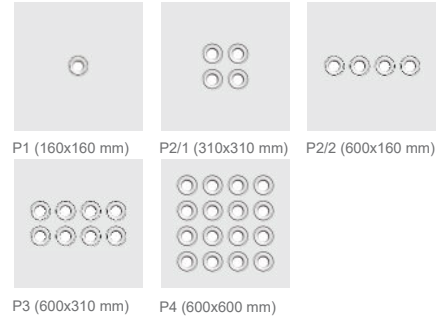
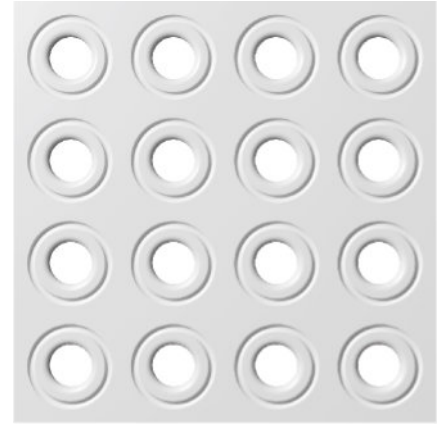

PDA16F



UN 2065

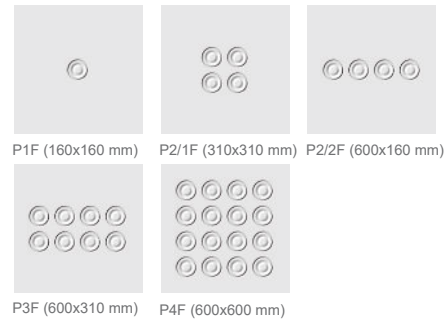
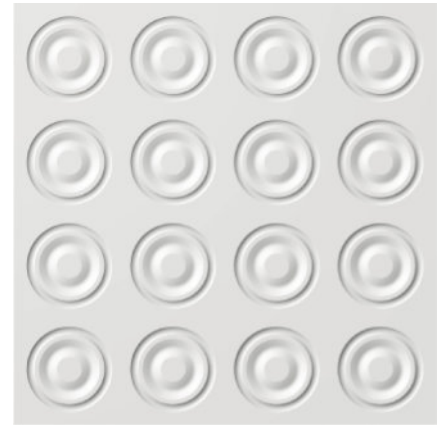

PDA17

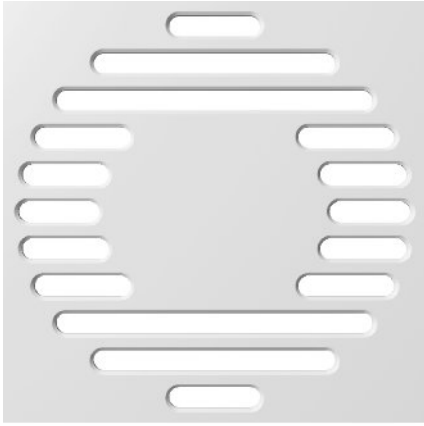

P2 (300x300 mm) P3 (600x280 mm) P4 (600x600 mm)



LAK LAK LACQUER AA 19, 22 mm

PDA17F



P2F (300x300 mm) P3F (600x280 mm) P4F (600x600 mm)





LAK
LAK
LACQUER AA
19, 22 mm

PDA18

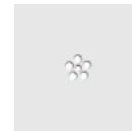
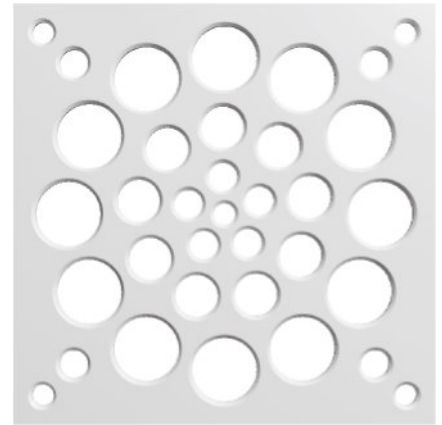

P1 (180x180 mm)

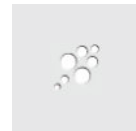

P2 (300x300 mm)



P3 (360x360 mm)

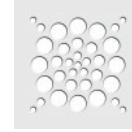

P4 (600x600 mm)



PDA18F

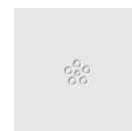

P1F (180x180 mm)

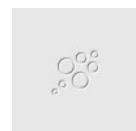

P2F (300x300 mm)



P3F (360x360 mm)



P4F (600x600 mm)

PDA19

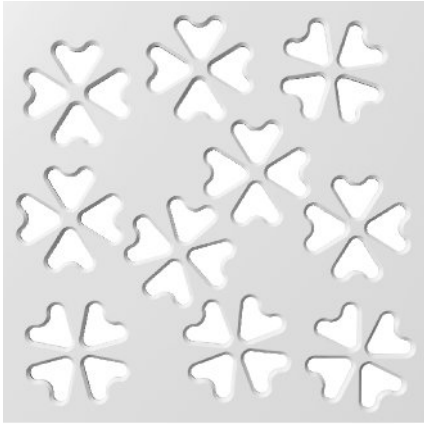

P1 (180x180 mm)



P2 (300x300 mm)



P3 (300x600 mm)



P4 (600x600 mm)



PT 5009



LAK
LAK
LACQUER
AA
19, 22 mm

PDA19F



P1F (180x180 mm)



P2F (300x300 mm)



P3F (300x600 mm)



P4F (600x600 mm)



PDA20



PT 5007



LAK LAK LACQUER AA 19, 22 mm

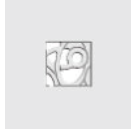
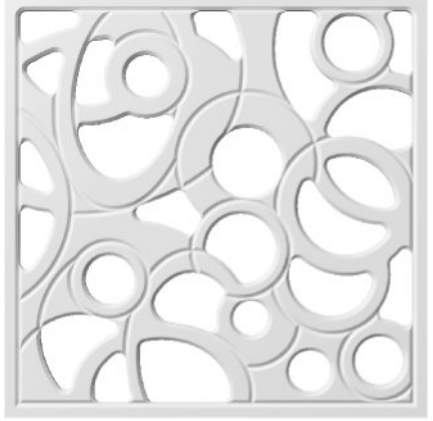

P2 (300x300 mm)



P4 (600x600 mm)

PDA20F



P2F (300x300 mm)



P4F (600x600 mm)



PDA21

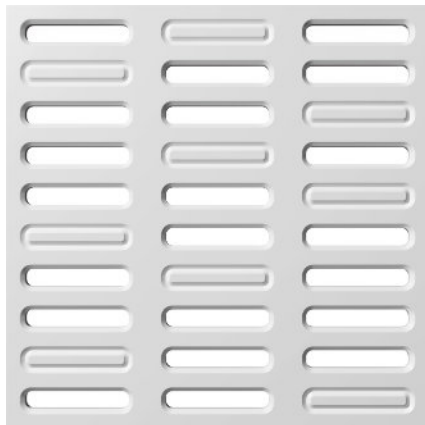

P1 (215x260 mm) P2/1 (408x260 mm) P2/2 (600x148 mm)



P2/3 (215x600 mm) P3 (600x260 mm) P4 (600x600 mm)



UN 5003, HG 9700



LAK
LAK
LACQUER AA
19, 22 mm

PDA21F



P1F (215x260 mm) P2/1F (408x260 mm) P2/2F (600x148 mm)



P2/3F (215x600 mm) P3F (600x260 mm) P4F (600x600 mm)



DM 2508



PDA22



UN 1001



LAK
LAK
LACQUER AA
19, 22 mm

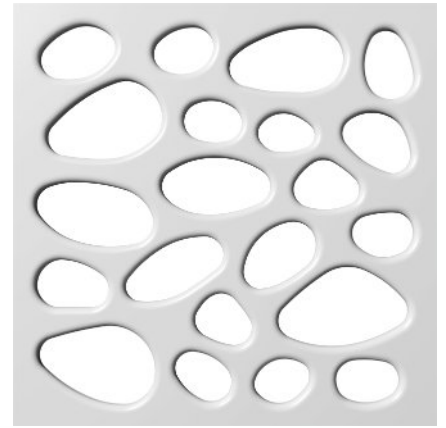

P2 (600x225 mm) P3 (600x338 mm) P4 (600x600 mm)



HG 7015



PDA22F



P2F (600x225 mm) P3F (600x338 mm) P4F (600x600 mm)

PDA23



L2/1 (600x300 mm) L2/2 (600x290 mm) L4 (600x655 mm)



P4 (630x630 mm)



UN 5004



LAK
LAK
LACQUER AA
1,9, 22 mm

PDA23F



L2/1F (600x300 mm) L2/2F (600x290 mm) L4F (600x655 mm)



P4F (630x630 mm)



HG 9700





HG 9700



LAK
LAK
LACQUER AA
19, 22 mm

PDA24

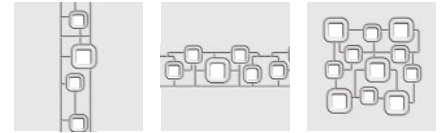

L2/1 (228 mm) L2/2 (256 mm) P4 (600x600 mm)



NCS S 3005



PDA24F

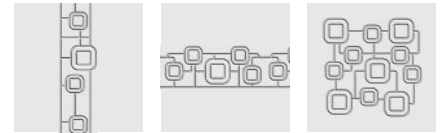

L2/1F (228 mm) L2/2F (256 mm) P4F (600x600 mm)

PDA25

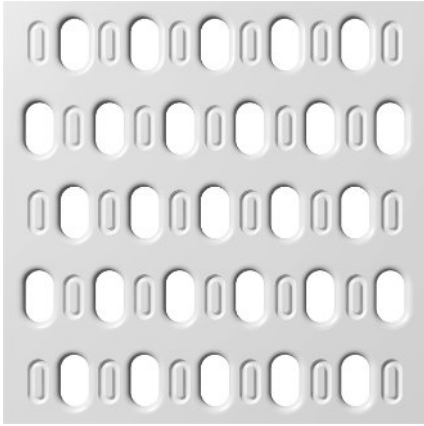

P2/1 (300x252 mm)	P2/2 (600x136 mm)	P3/1 (400x368 mm)
P3/2 (600x368 mm)	P4 (600x600 mm)	



UN 5003

A: 10,12mm
LAK LACQUER AA 19, 22 mm

PDA25F



P2/1F (300x252 mm)	P2/2F (600x136 mm)	P3/1F (400x368 mm)
P3/2F (600x368 mm)	P4F (600x600 mm)	



RAL 1013

7mm
10,12,18,22 mm

PDA26



UN 5004



LAK LAK LACQUER AA 19, 22 mm

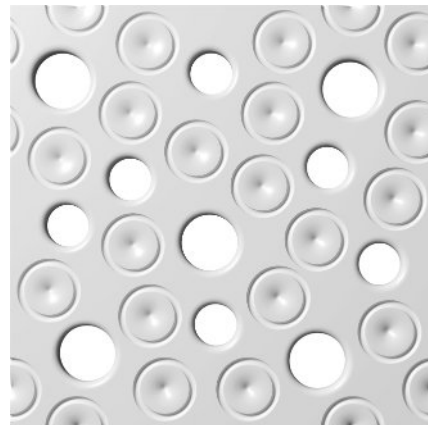

L3 (402 mm)

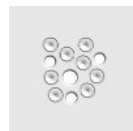

P3/1 (388x414 mm)

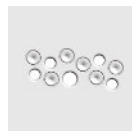

P3/2 (600x276 mm)

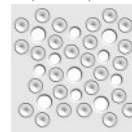

P4 (735x710 mm)

PDA26F



UN 5003

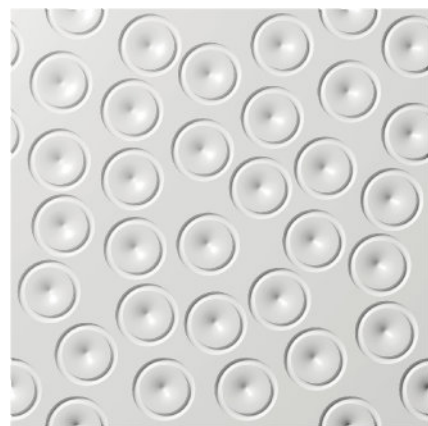

L3F (402 mm)

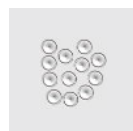

P3/1F (388x414 mm)

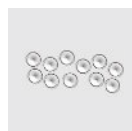

P3/2F (600x276 mm)

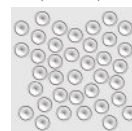

P4F (735x710 mm)

PDA27

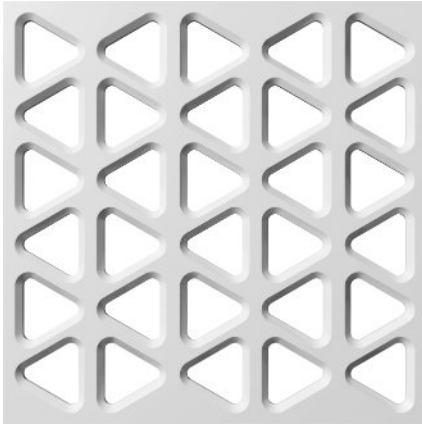

P2/1 (264x343 mm) P2/2 (152x600 mm) P2/3 (600x172 mm)



P3/1 (264x600 mm) P3/2 (600x258 mm) P3/3 (600x430 mm)



P4 (600x600 mm)



UN 4000



LAK LAK LACQUER AA 19, 22 mm

PDA27F



P2/1F (264x343 mm) P2/2F (152x600 mm) P2/3F (600x172 mm)



P3/1F (264x600 mm) P3/2F (600x258 mm) P3/3F (600x430 mm)



P4F (600x600 mm)



UN 2065, UN 5004



PDA28



HG 9700



LAK
LAK
LACQUER AA
19, 22 mm

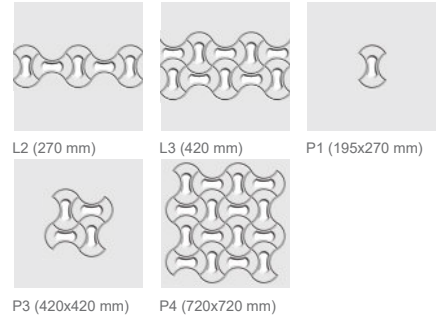

PDA28F



PT 5001

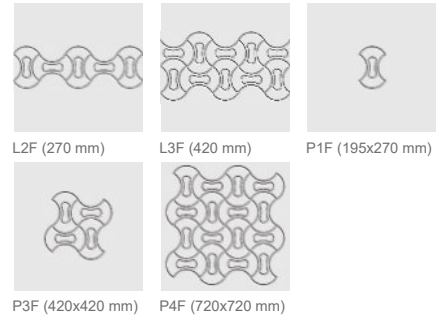

PDA29

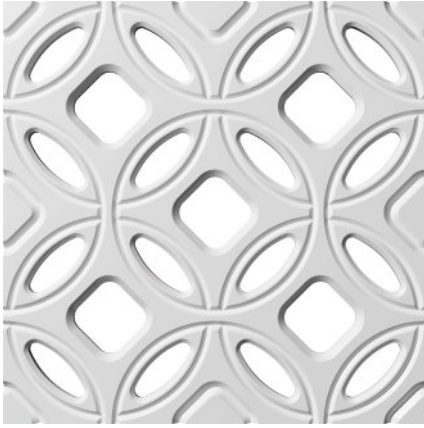

L2 (300 mm) P2 (300x300 mm) P4 (600x600 mm)



LAK
LAK
LACQER AA
19, 22 mm

PDA29F

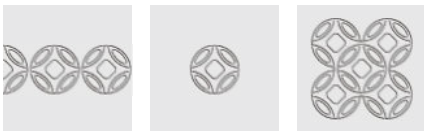

L2F (300 mm) P2F (300x300 mm) P4F (600x600 mm)



PDA30



UN 5003



LAK LAK LACQER AA 19,22 mm



L4 (1016 mm)

PDA30F



HG 8810



L4F (1016 mm)



DESIGN QUALITY TECHNOLOGY

DEKORAČNÍ PANELE XLA

CZ: Panely z nové produktové řady Moduloform - průhledné panely XLA - jsou ideální pro individualisty, kteří oceňují moderní design. Rovněž naleznou uznání mezi lidmi, kteří hledají inovativní řešení uspořádání prostoru v makro měřítku. Panel XLA umožňuje vytvořit interiér, který má jedinečný charakter. Jako subtilní dělící příčka jsou panely XLA vhodné do každého prostoru - obývacího pokoje, kuchyně i kanceláře.

Seznamte se prosím s novou řadou velkoformátových panelů XLA v rozměrech 1200 x 2400 mm a 1200 x 1200 mm.

DEKORAČNÉ PANELE XLA

SK: Panely z novej produktovej rady Moduloform - priehľadné panely XLA - sú ideálne pre individualistov, ktorí oceňujú moderný dizajn. Takisto nájdú uznanie medzi ľuďmi, ktorí hľadajú inovatívne riešenia usporiadania priestoru v makro mierke. Panel XLA umožňuje vytvoriť interiér, ktorý má jedinečný charakter. Ako subtilne deliaca priečka sú panely XLA vhodné do každého priestoru - obývacej izby, kuchyne i kancelárie.

Zoznámte sa prosím s novou radou veľkoformátových panelov XLA v rozmeroch 1200 x 2400 mm a 1200 x 1200 mm.

DECORATIVE PANEL XLA

EN: Panels from the new Moduloform - openwork XLA product line - are ideal for individualists who appreciate modern design. They will also find recognition among people looking for innovative solutions for certain space arrangements in macro scale. The XLA panel allows to create the interior, which has an unique character. Panels as the subtle dividing wall - fit to every space - living room as well as kitchen and office.

We invite you to make yourself familiar with a new range of large-format XLA openwork panels available in the dimension of 1200 x 2400 mm and 1200 x 1200 mm.

XLA 1 R

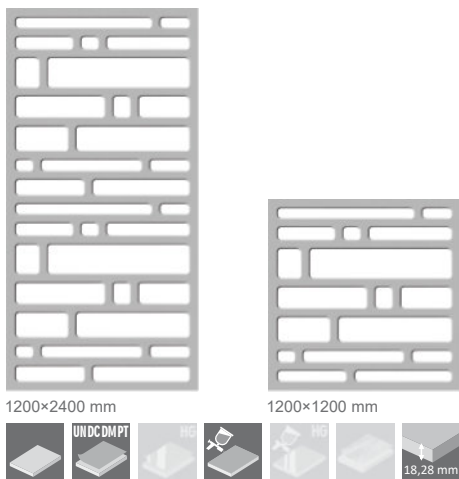

1200x2400 mm

1200x1200 mm



XLA 2 R

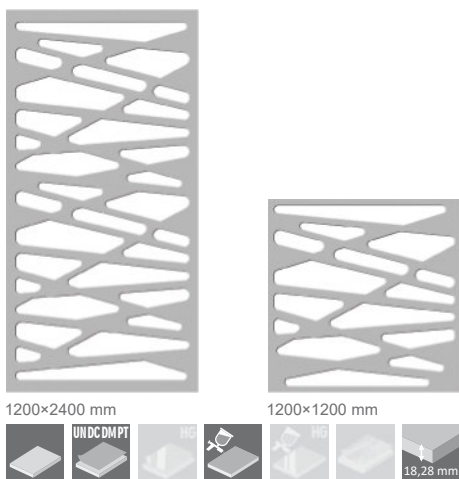

1200x2400 mm

1200x1200 mm



XLA 3 R

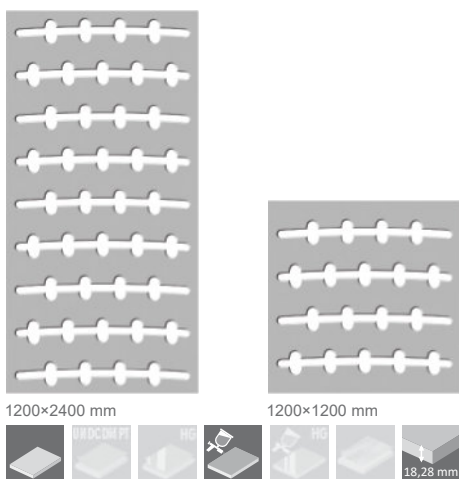

1200x2400 mm

1200x1200 mm



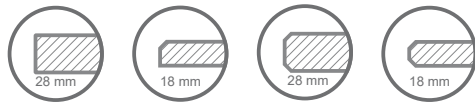

XLA 4 R



1200×2400 mm

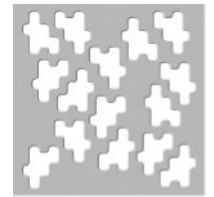

1200×1200 mm



XLA 5 R

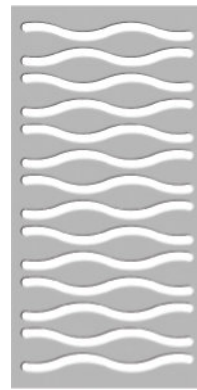

1200×2400 mm

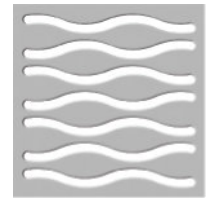

1200×1200 mm



XLA 6 R

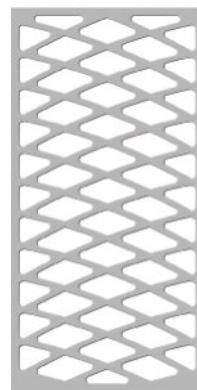

1200×2400 mm

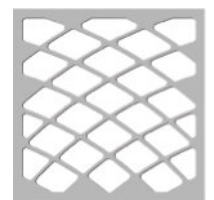

1200×1200 mm



XLA 7 R

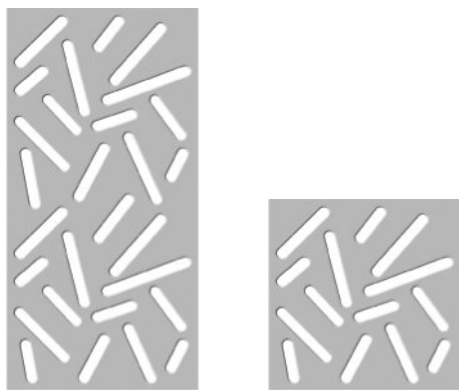

1200x2400 mm

1200x1200 mm



XLA 8 R

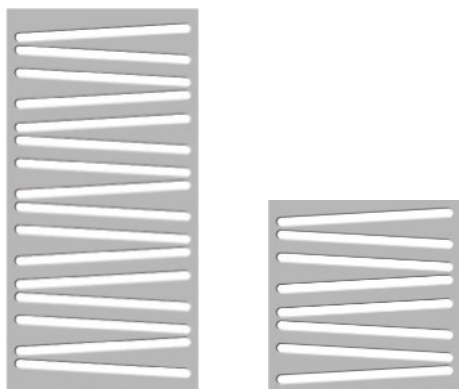

1200x2400 mm

1200x1200 mm

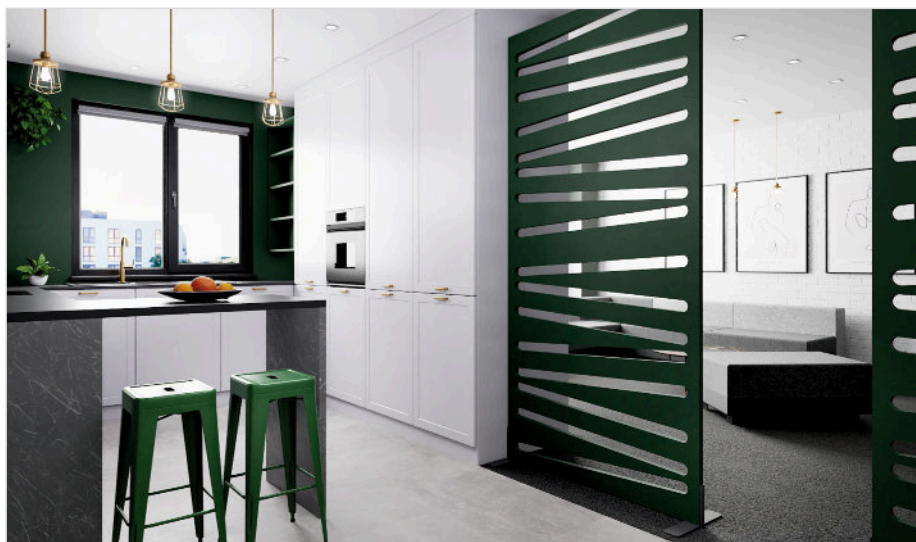

XLA 9 R

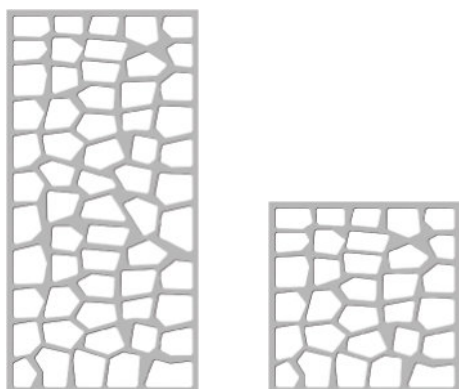

1200x2400 mm

1200x1200 mm

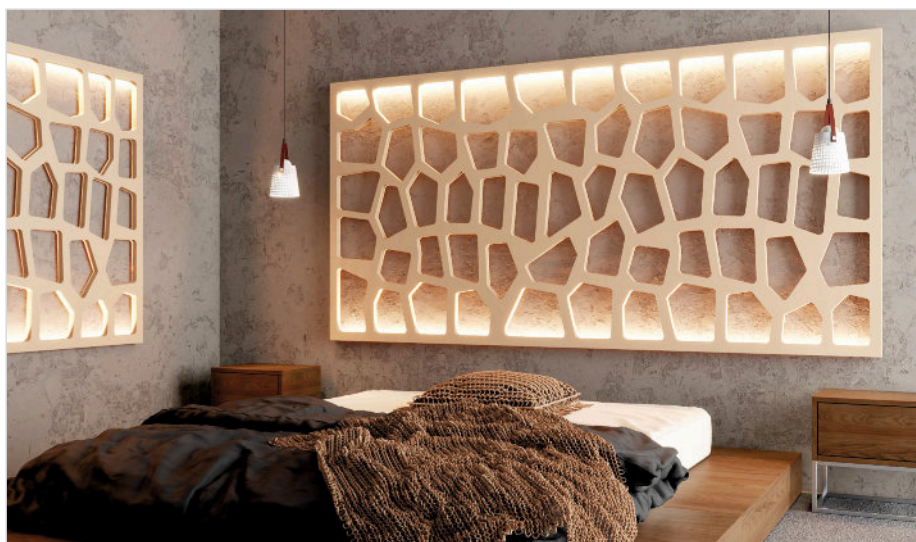

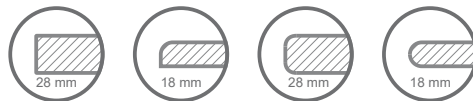
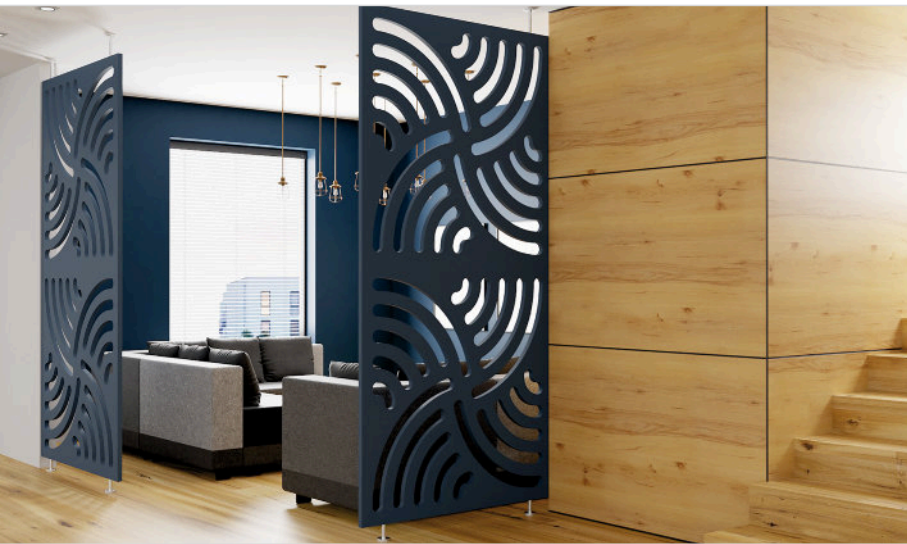

XLA 10 R



1200×2400 mm



1200×1200 mm

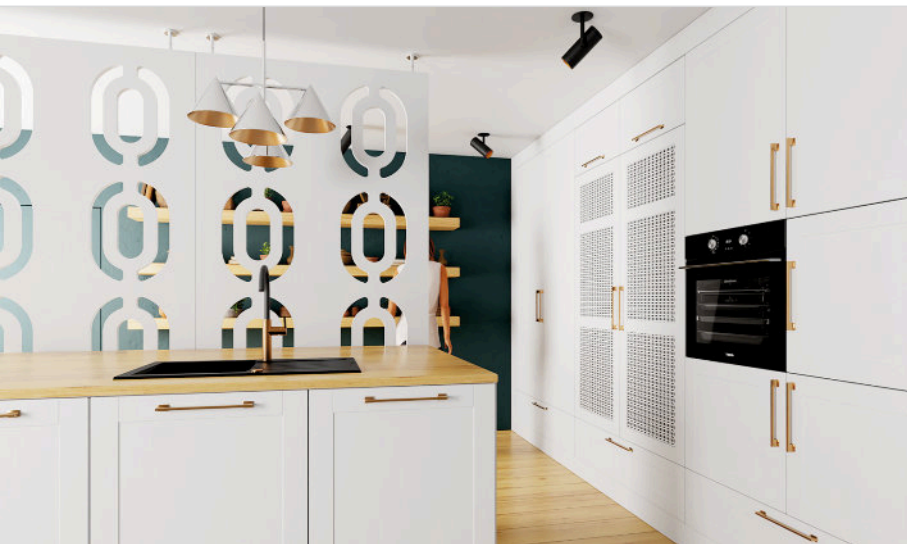

XLA 11 R



1200×2400 mm



1200×1200 mm



XLA 12 R

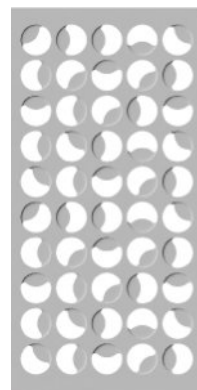

1200×2400 mm

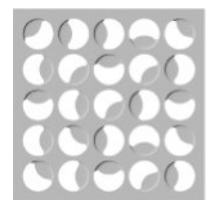

1200×1200 mm



XLA 13 R

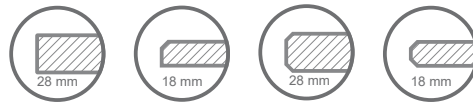
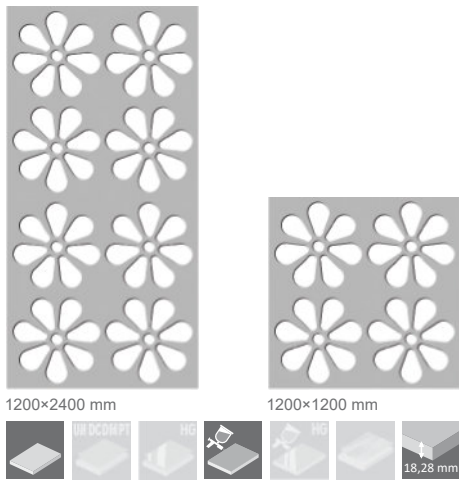

XLA 14 R

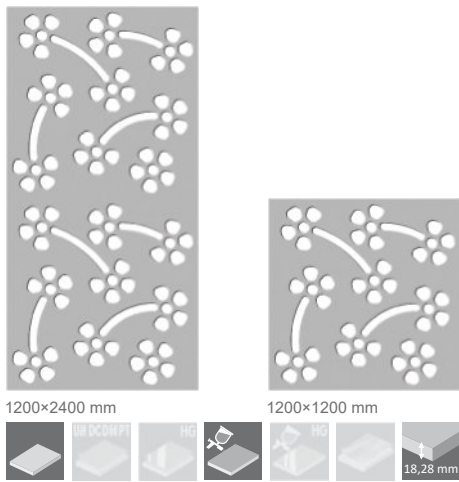

XLA 15 R

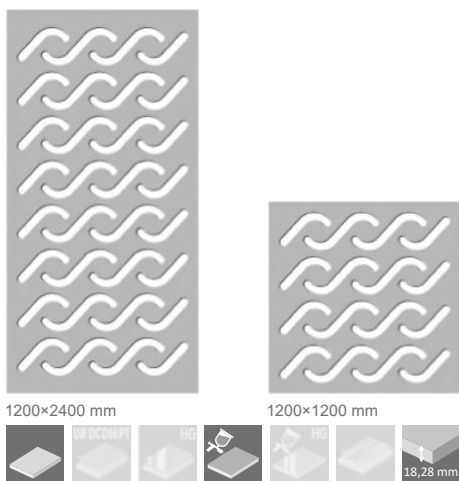

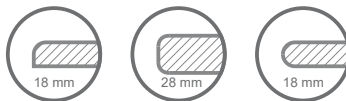

XLA 16 R

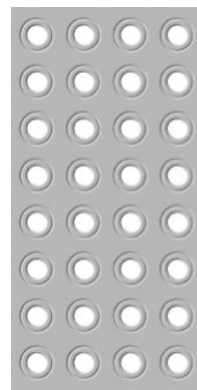

1200×2400 mm

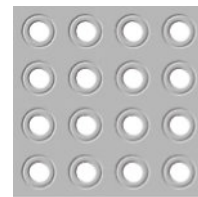

1200×1200 mm

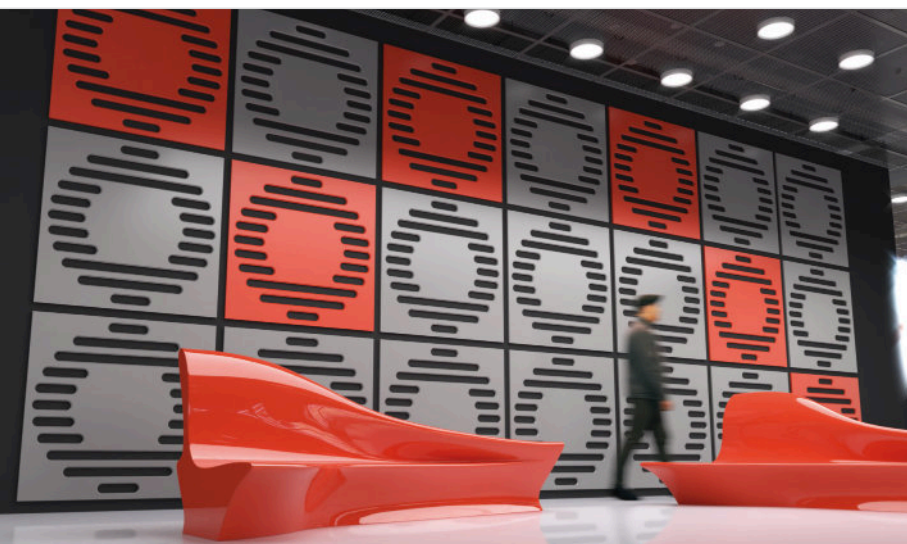

XLA 17 R

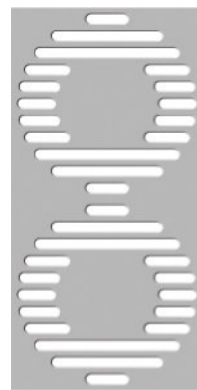

1200×2400 mm

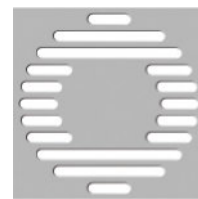

1200×1200 mm



XLA 18 R

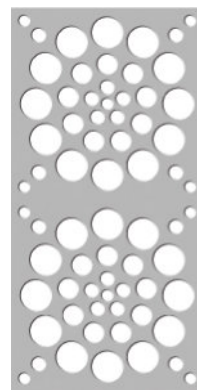

1200×2400 mm

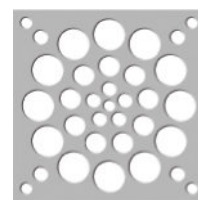

1200×1200 mm



XLA 19 R

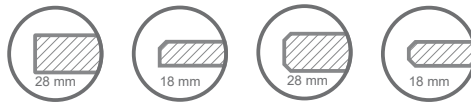
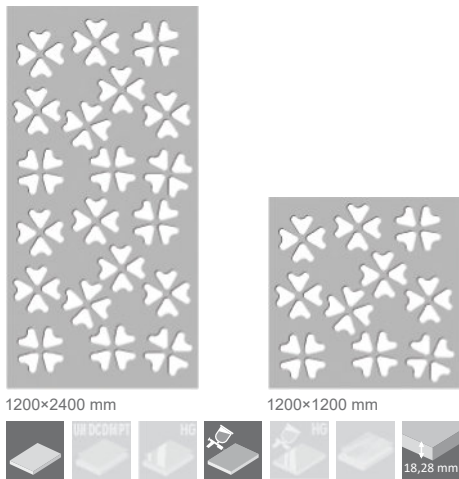

XLA 20 R

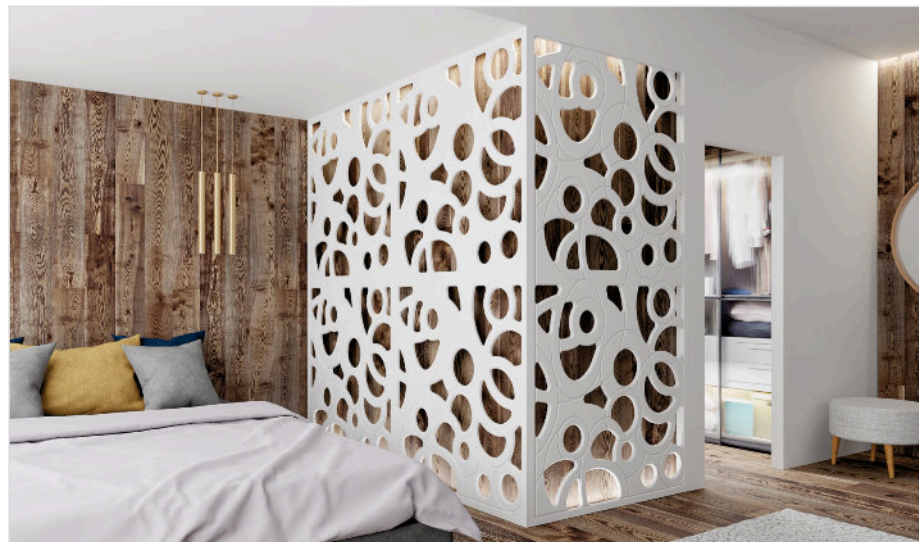
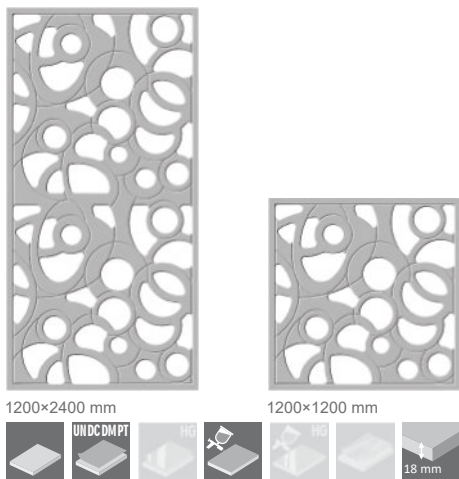

XLA 21 R

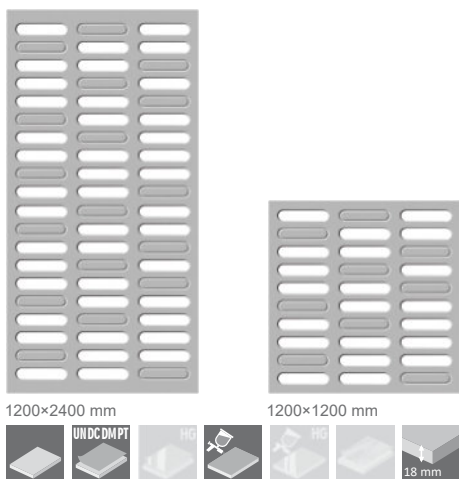

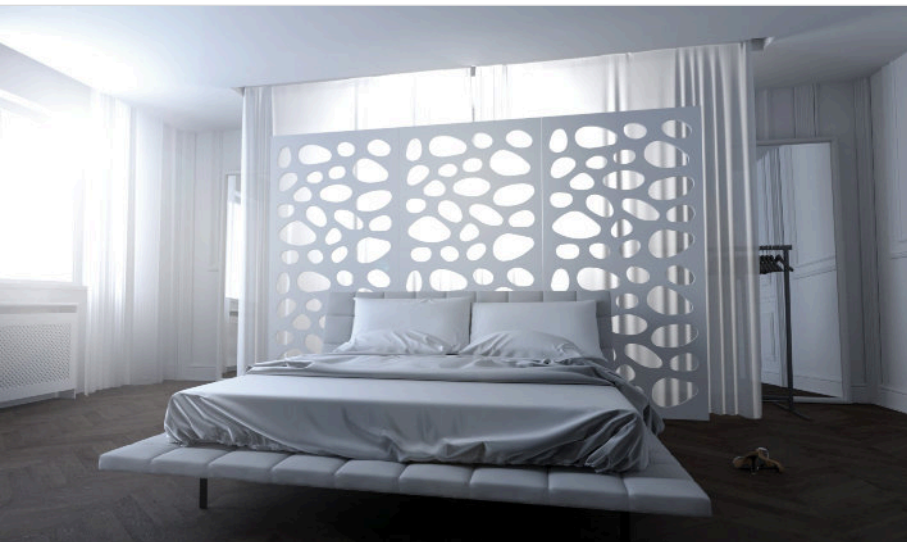

XLA 22 R

XLA 22

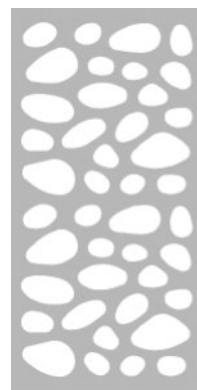

1200×2400 mm

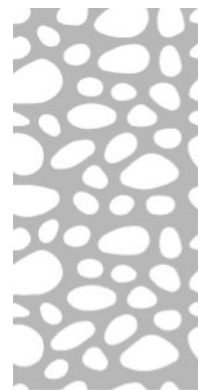

1200×2400 mm



XLA 23 R



1200×2400 mm



1200×1200 mm

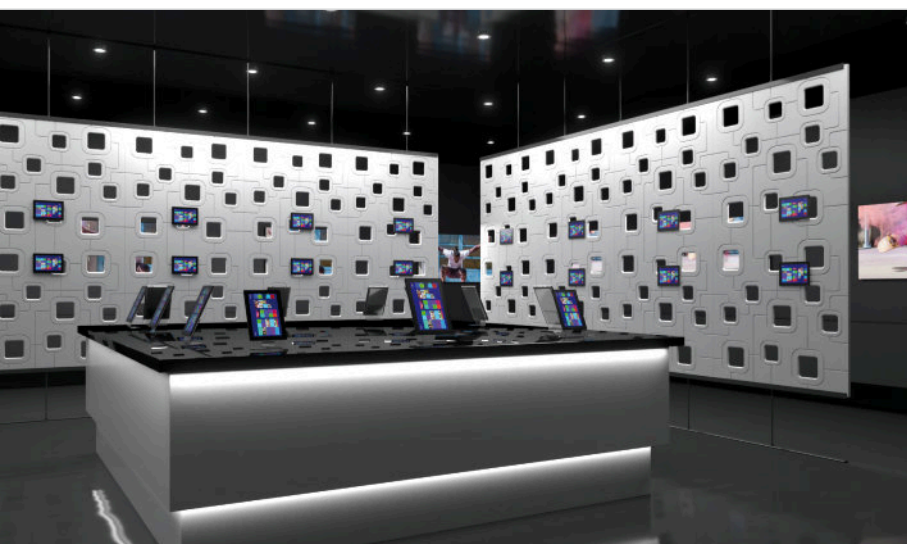

XLA 24 R

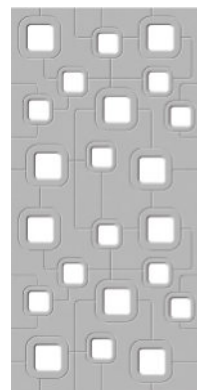

1200×2400 mm



1200×1200 mm



XLA 25 R

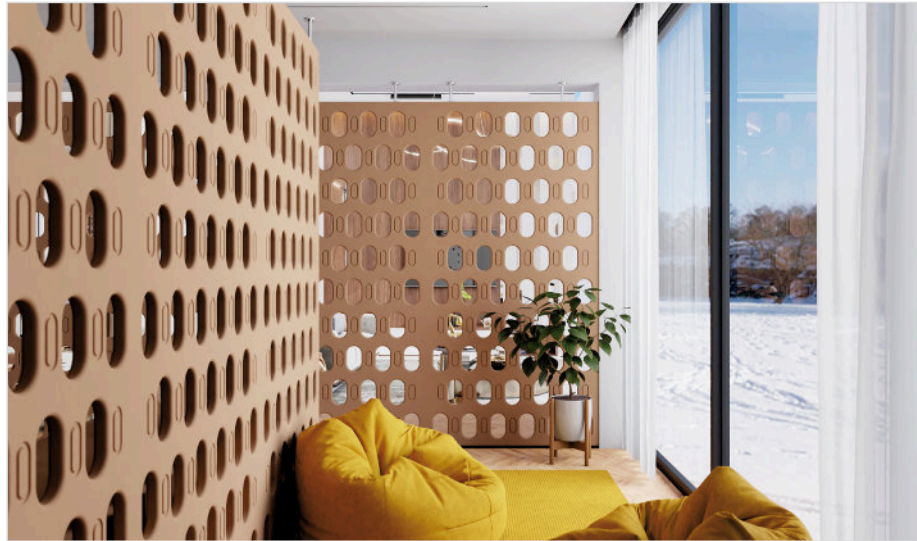
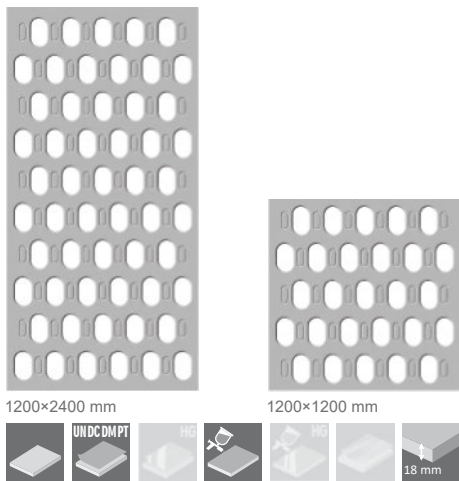

XLA 26 R

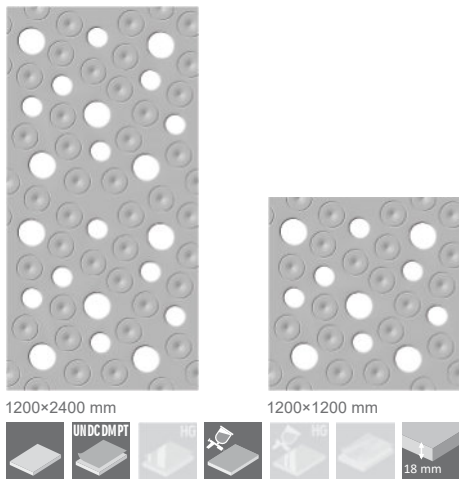

XLA 27 R

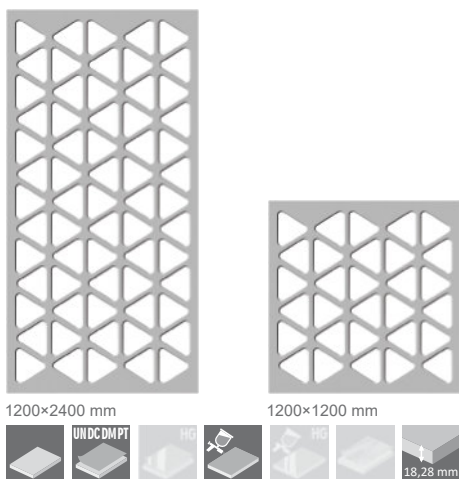



DM2448

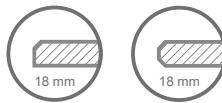

XLA 28 R

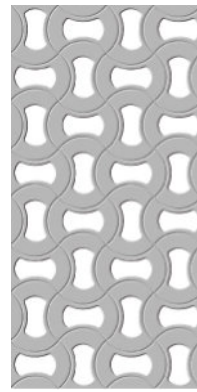

1200×2400 mm

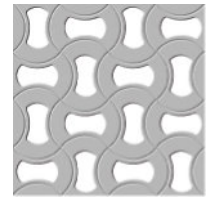

1200×1200 mm



XLA 29 R

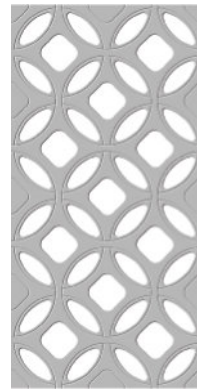

1200×2400 mm

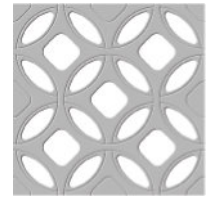

1200×1200 mm



XLA 30 R



1200×2400 mm



1200×1200 mm



XLA 31 R

XLA 31

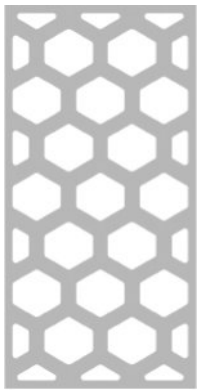

1200×2400 (2750) mm

1200×2400 (2750) mm

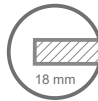

XLA 32 R

XLA 32

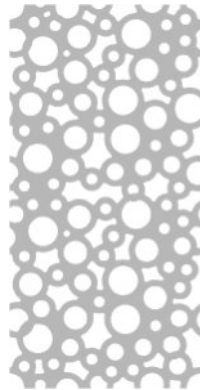
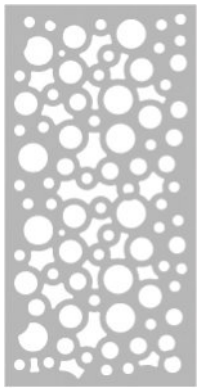

1200×2400 (2750) mm

1200×2400 (2750) mm



XLA 33 R

XLA 33

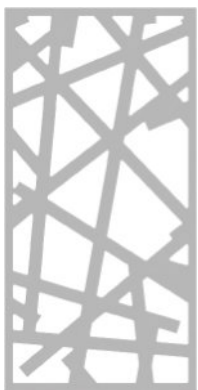

1200×2400 (2750) mm

1200×2400 (2750) mm





XLA 34 R

XLA 34



1200×2400 (2750) mm



1200×2400 (2750) mm

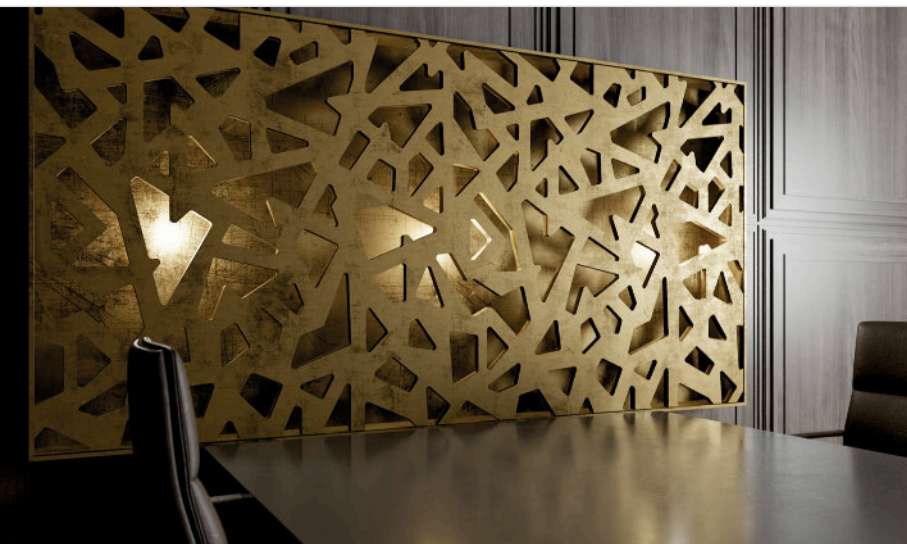

XLA 35 R

XLA 35



1200×2400 (2750) mm

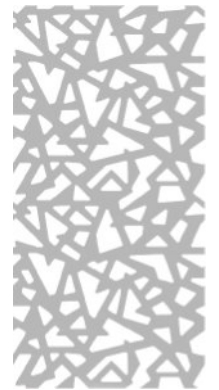

1200×2400 (2750) mm



XLA 36 R

XLA 36



1200×2400 (2750) mm

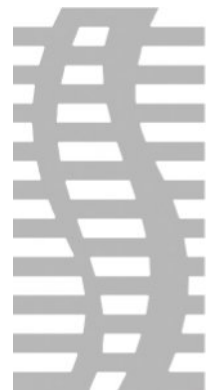

1200×2400 (2750) mm



XLA 37 R

XLA 37



1200×2400 (2750) mm

1200×2400 (2750) mm



18,28 mm

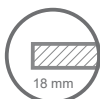

XLA 38 R

XLA 38

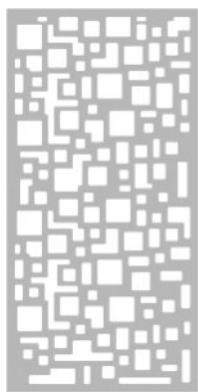

1200×2400 (2750) mm

1200×2400 (2750) mm



18,28 mm



XLA 39 R

XLA 39



1200×2400 (2750) mm

1200×2400 (2750) mm



18,28 mm

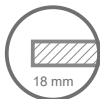

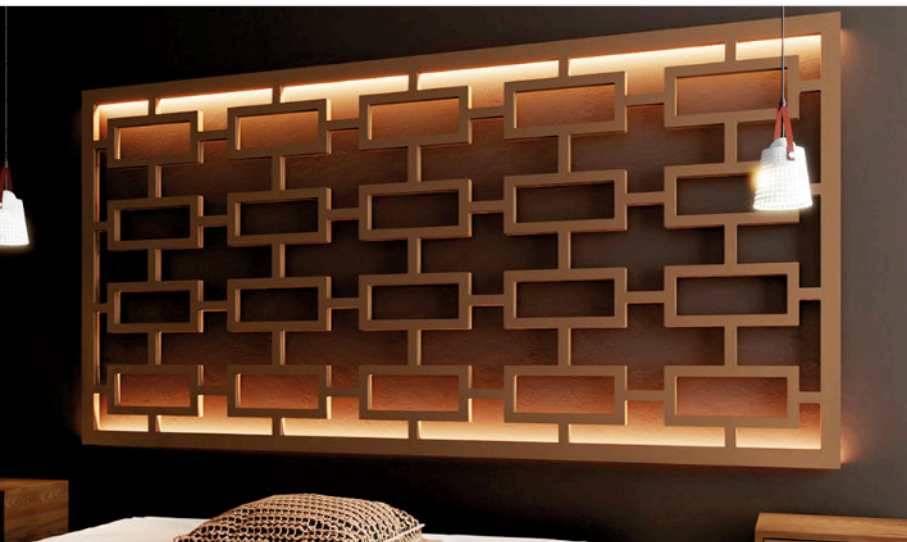

XLA 40 R

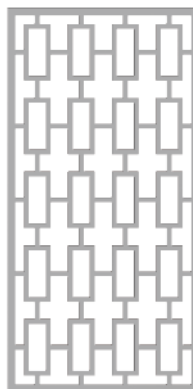

1200×2400 mm



XLA 41 R **NEW!**



1200×2400 mm



XLA 42 R **NEW!**



1200×2400 mm



XLA 43 R **NEW!**

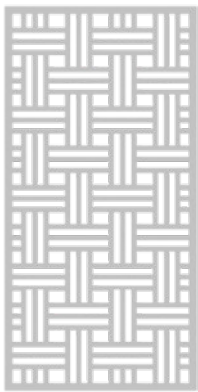

1200x2400 mm



XLA 44 R **NEW!**

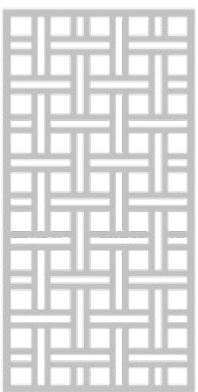

1200x2400 mm





UN 2065

proform®

KRYTY RADIÁTORŮ

CZ: Naše kryty radiátorů změni neatraktivní nebo dokonce ošklivý radiátor na estetický prvek, který tvoří nedílnou součást celé místnosti. Rychlou a snadnou možností, jak starý radiátor vylepšit, je schovat ho za náš kryt, který se stane novým designovým prvkem místnosti. Kryty jsou dostupné v šesti standardních provedeních, různých velikostech a barvách, s matným nebo vysoce lesklým povrchem. Jako doplněk ke krytům můžeme nabídnout také parapety a instalační prvky.

KRYTY RADIÁTOROV

SK: Naše kryty radiátorov zmenia neatraktívny alebo dokonca škaredý radiátor na estetický prvok, ktorý tvorí neoddeliteľnú súčasť celej miestnosti. Rýchlu a jednoduchou možnosťou ako starý radiátor vylepšiť je schovať ho za náš kryt, ktorý sa stane novým dizajnovým prvkom miestnosti. Kryty sú dostupné v šiestich štandardných prevedeniach, rôznych veľkostiach a farbách, s matným alebo vysoko lesklým povrchom. Ako doplnok ku krytom môžeme ponúknuť tiež parapety a inštaláčne prvky.

RADIATOR COVERS

EN: Our radiator covers can transform an unattractive or even ugly radiator into an aesthetic element, constituting an integral part of the entire room. In a prompt and easy way, an old radiator hidden behind our cover becomes a new design highlight of your room. The element is available in six standard designs, in various sizes and colours, with a matt or high gloss finish. We also offer window sills and an installation system for our covers.





GALAXY 140
PDA 23
UN 2065

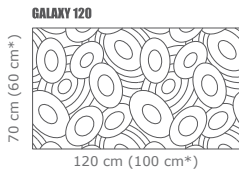

MOON 140
PDA 26
UN-5003

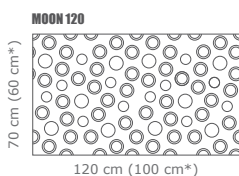

*DOPORUČENÝ ROZMĚR RADIÁTORU
*DOPORUČENÝ ROZMĚR RADIÁTORA
*RECOMMENDED RADIATOR SIZE

GALAXY (PDA 23)



DOPORUČENÝ ROZMĚR RADIÁTORU:
DOPORUČENÝ ROZMĚR RADIÁTORA:
RECOMMENDED RADIATOR SIZE:

GALAXY 70	RADIÁTOR/RADIÁTOR/RADIATOR: H60 W50
GALAXY 80	RADIÁTOR/RADIÁTOR/RADIATOR: H60 W60
GALAXY 90	RADIÁTOR/RADIÁTOR/RADIATOR: H60 W70
GALAXY 100	RADIÁTOR/RADIÁTOR/RADIATOR: H60 W80
GALAXY 110	RADIÁTOR/RADIÁTOR/RADIATOR: H60 W90
GALAXY 120	RADIÁTOR/RADIÁTOR/RADIATOR: H60 W100
GALAXY 130	RADIÁTOR/RADIÁTOR/RADIATOR: H60 W110
GALAXY 140	RADIÁTOR/RADIÁTOR/RADIATOR: H60 W120
GALAXY 150	RADIÁTOR/RADIÁTOR/RADIATOR: H60 W130
GALAXY 160	RADIÁTOR/RADIÁTOR/RADIATOR: H60 W140
GALAXY 170	RADIÁTOR/RADIÁTOR/RADIATOR: H60 W150
GALAXY 180	RADIÁTOR/RADIÁTOR/RADIATOR: H60 W160

MOON (PDA 26)



HG-4200

DOPORUČENÝ ROZMĚR RADIÁTORU:
DOPORUČENÝ ROZMĚR RADIÁTORA:
RECOMMENDED RADIATOR SIZE:

MOON 70	RADIÁTOR/RADIÁTOR/RADIATOR: H60 W50
MOON 80	RADIÁTOR/RADIÁTOR/RADIATOR: H60 W60
MOON 90	RADIÁTOR/RADIÁTOR/RADIATOR: H60 W70
MOON 100	RADIÁTOR/RADIÁTOR/RADIATOR: H60 W80
MOON 110	RADIÁTOR/RADIÁTOR/RADIATOR: H60 W90
MOON 120	RADIÁTOR/RADIÁTOR/RADIATOR: H60 W100
MOON 130	RADIÁTOR/RADIÁTOR/RADIATOR: H60 W110
MOON 140	RADIÁTOR/RADIÁTOR/RADIATOR: H60 W120
MOON 150	RADIÁTOR/RADIÁTOR/RADIATOR: H60 W130
MOON 160	RADIÁTOR/RADIÁTOR/RADIATOR: H60 W140
MOON 170	RADIÁTOR/RADIÁTOR/RADIATOR: H60 W150
MOON 180	RADIÁTOR/RADIÁTOR/RADIATOR: H60 W160

SATURN (PDA 24)



UN-0111

DOPORUČENÝ ROZMĚR RADIÁTORU:
DOPORUČENÝ ROZMĚR RADIÁTORA:
RECOMMENDED RADIATOR SIZE:

- SATURN 70**
RADIÁTOR/RADIÁTOR/RADIATOR: H60 W50
- SATURN 80**
RADIÁTOR/RADIÁTOR/RADIATOR: H60 W60
- SATURN 90**
RADIÁTOR/RADIÁTOR/RADIATOR: H60 W70
- SATURN 100**
RADIÁTOR/RADIÁTOR/RADIATOR: H60 W80
- SATURN 110**
RADIÁTOR/RADIÁTOR/RADIATOR: H60 W90
- SATURN 120**
RADIÁTOR/RADIÁTOR/RADIATOR: H60 W100
- SATURN 130**
RADIÁTOR/RADIÁTOR/RADIATOR: H60 W110
- SATURN 140**
RADIÁTOR/RADIÁTOR/RADIATOR: H60 W120
- SATURN 150**
RADIÁTOR/RADIÁTOR/RADIATOR: H60 W130
- SATURN 160**
RADIÁTOR/RADIÁTOR/RADIATOR: H60 W140
- SATURN 170**
RADIÁTOR/RADIÁTOR/RADIATOR: H60 W150
- SATURN 180**
RADIÁTOR/RADIÁTOR/RADIATOR: H60 W160



SATURN 140
PDA 24
HG-0340

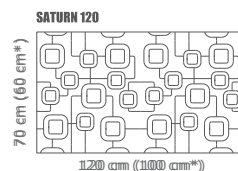

GEO (PDA 2)

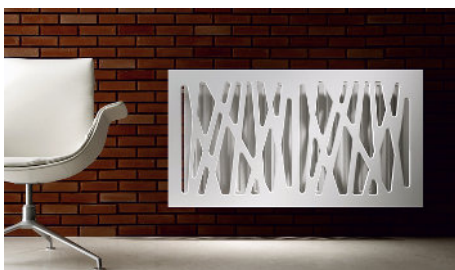

HG-9700

DOPORUČENÝ ROZMĚR RADIÁTORU:
DOPORUČENÝ ROZMĚR RADIÁTORA:
RECOMMENDED RADIATOR SIZE:

- GEO 70**
RADIÁTOR/RADIÁTOR/RADIATOR: H60 W50
- GEO 80**
RADIÁTOR/RADIÁTOR/RADIATOR: H60 W60
- GEO 90**
RADIÁTOR/RADIÁTOR/RADIATOR: H60 W70
- GEO 100**
RADIÁTOR/RADIÁTOR/RADIATOR: H60 W80
- GEO 110**
RADIÁTOR/RADIÁTOR/RADIATOR: H60 W90
- GEO 120**
RADIÁTOR/RADIÁTOR/RADIATOR: H60 W100
- GEO 130**
RADIÁTOR/RADIÁTOR/RADIATOR: H60 W110
- GEO 140**
RADIÁTOR/RADIÁTOR/RADIATOR: H60 W120
- GEO 150**
RADIÁTOR/RADIÁTOR/RADIATOR: H60 W130
- GEO 160**
RADIÁTOR/RADIÁTOR/RADIATOR: H60 W140
- GEO 170**
RADIÁTOR/RADIÁTOR/RADIATOR: H60 W150
- GEO 180**
RADIÁTOR/RADIÁTOR/RADIATOR: H60 W160



GEO 130
PDA 2
HG-2800

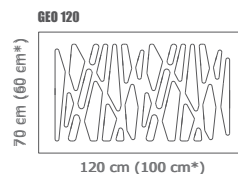



RINGS 130
PDA 16
HG-0115

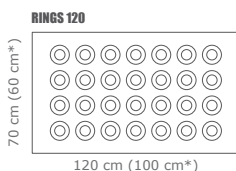

STICKS 130
PDA 7
UN 2065

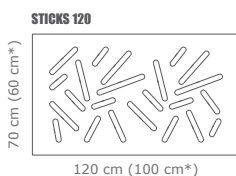

RINGS (PDA 16)



HG-4200

DOPORUČENÝ ROZMĚR RADIÁTORU:
DOPORUČENÝ ROZMER RADIÁTORA:
RECOMMENDED RADIATOR SIZE:

- RINGS 70**
RADIÁTOR/RADIÁTOR/RADIATOR: H60 W50
- RINGS 80**
RADIÁTOR/RADIÁTOR/RADIATOR: H60 W60
- RINGS 90**
RADIÁTOR/RADIÁTOR/RADIATOR: H60 W70
- RINGS 100**
RADIÁTOR/RADIÁTOR/RADIATOR: H60 W80
- RINGS 110**
RADIÁTOR/RADIÁTOR/RADIATOR: H60 W90
- RINGS 120**
RADIÁTOR/RADIÁTOR/RADIATOR: H60 W100
- RINGS 130**
RADIÁTOR/RADIÁTOR/RADIATOR: H60 W110
- RINGS 140**
RADIÁTOR/RADIÁTOR/RADIATOR: H60 W120
- RINGS 150**
RADIÁTOR/RADIÁTOR/RADIATOR: H60 W130
- RINGS 160**
RADIÁTOR/RADIÁTOR/RADIATOR: H60 W140
- RINGS 170**
RADIÁTOR/RADIÁTOR/RADIATOR: H60 W150
- RINGS 180**
RADIÁTOR/RADIÁTOR/RADIATOR: H60 W160

STICKS (PDA 7)



HG-0340

DOPORUČENÝ ROZMĚR RADIÁTORU:
DOPORUČENÝ ROZMER RADIÁTORA:
RECOMMENDED RADIATOR SIZE:

- STICKS 70**
RADIÁTOR/RADIÁTOR/RADIATOR: H60 W50
- STICKS 80**
RADIÁTOR/RADIÁTOR/RADIATOR: H60 W60
- STICKS 90**
RADIÁTOR/RADIÁTOR/RADIATOR: H60 W70
- STICKS 100**
RADIÁTOR/RADIÁTOR/RADIATOR: H60 W80
- STICKS 110**
RADIÁTOR/RADIÁTOR/RADIATOR: H60 W90
- STICKS 120**
RADIÁTOR/RADIÁTOR/RADIATOR: H60 W100
- STICKS 130**
RADIÁTOR/RADIÁTOR/RADIATOR: H60 W110
- STICKS 140**
RADIÁTOR/RADIÁTOR/RADIATOR: H60 W120
- STICKS 150**
RADIÁTOR/RADIÁTOR/RADIATOR: H60 W130
- STICKS 160**
RADIÁTOR/RADIÁTOR/RADIATOR: H60 W140
- STICKS 170**
RADIÁTOR/RADIÁTOR/RADIATOR: H60 W150
- STICKS 180**
RADIÁTOR/RADIÁTOR/RADIATOR: H60 W160

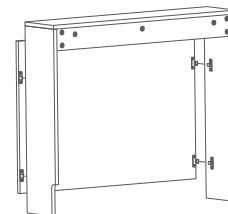

SKŘÍŇKA KRYTU RADIÁTORŮ / SKRINKA KRYTU RADIÁTOROV RADIATOR CABINETS HOUSINGS

TYP/TYPE:	600	700	800	900	1000	1100	1200	1300	1400	1500	1600	1700	1800
radiátor/radiátor/radiator (šířka / šířka / width):	400	500	600	700	800	900	1000	1100	1200	1300	1400	1500	1600
skříňka/skrinka/housing 1,2 (šířka / šířka / width):	636	736	836	936	1036	1136	1236	1336	1436	1536	1636	1736	1836
skříňka/skrinka/housing 3 (šířka / šířka / width):	656	756	856	956	1056	1156	1256	1356	1456	1556	1656	1756	1856
skříňka/skrinka/housing 4 (šířka / šířka / width):	600	700	800	900	1000	1100	1200	1300	1400	1500	1600	1700	1800
skříňka/skrinka/housing 1 (výška / výška / height):	878	878	878	878	878	878	878	878	878	878	878	878	878
skříňka/skrinka/housing 2, 3, 4 (výška / výška / height):	888	888	888	888	888	888	888	888	888	888	888	888	888
skříňka/skrinka/housing 1, 2, 3, 4 (hloubka / hlĺka / depth):	220	220	220	220	220	220	220	220	220	220	220	220	220

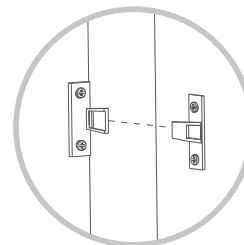

skříňka 1 / skrinka 1 / housing 1

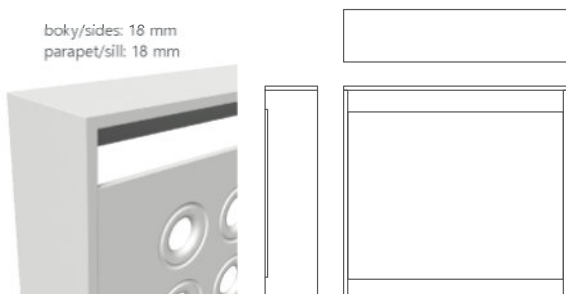

skříňka 2 / skrinka 2 / housing 2

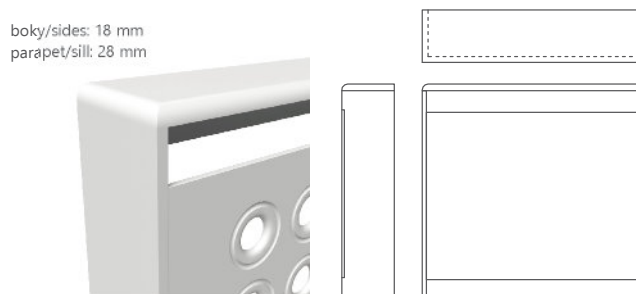

skříňka 3 / skrinka 3 / housing 3

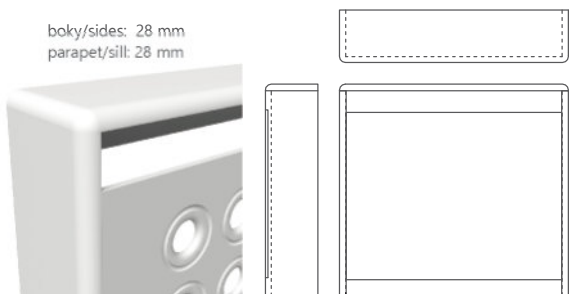

skříňka 4 / skrinka 4 / housing 4

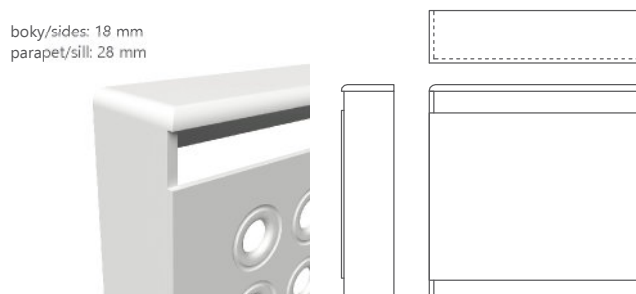

MONTÁŽNÍ SADY PRO KRYTY RADIÁTORŮ

MONTÁŽNE SADY PRE KRYTY RADIÁTOROV / INSTALLATION SETS FOR RADIATOR COVERS

Montážní sada krytu pro deskový radiátor:

Montážna sada krytu pre doskový radiátor:
Installation set:

ZMMG01

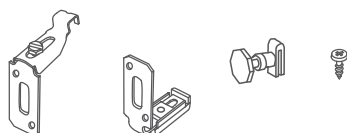

Adaptér pro žebrový radiátor:

Adaptér pre rebrový radiátor:
Adapter for installation kits
for column radiators:

ZMMG02

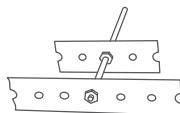

Adaptér pro rámový kryt radiátoru:

Adaptér pre rámový kryt radiátora:
Adapter for mounting frame radiator
cover on the column radiator:

ZMMG03

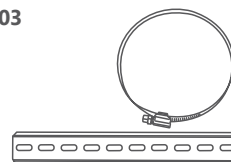

VÝBĚR INSTALAČNÍCH SAD PODLE TYPU RADIÁTORU A SKŘÍŇKY

VÝBER INŠTALAČNÝCH SAD PODĽA TYPU RADIÁTORA A SKRINKY / SELECTION OF INSTALLATION SETS

typ radiátoru typ radiátora / type of radiator	DESKOVÝ Doskový / panel radiators	ŽEBROVÝ, LITINOVÝ rebový, liatinový / column radiators
kryt radiátoru PDA kryt radiátora PDA covers / openwork radiator	ZMMG 01	ZMMG 01 + ZMMG 02
rámový kryt radiátorů rámový kryt radiátorov / frame radiator covers	ZMMG 01	ZMMG 01 + ZMMG 03



RÁMOVÉ KRYTY RADIÁTORŮ / RÁMOVÉ KRYTY RADIÁTOROV / FRAME RADIATOR COVERS

CL 03

CLASSIC II
VÝPLNĚ / VÝPLNE / GRILLES TYPES

rám
rám
frame  UN 2097  18 mm

síla mřížky
hrúbka mriežky
the grid strength  3 mm

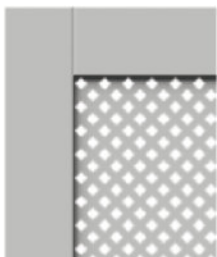

CL 01

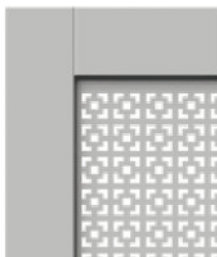

CL 02



CL 03

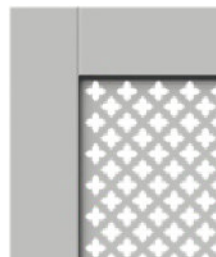

CL 04

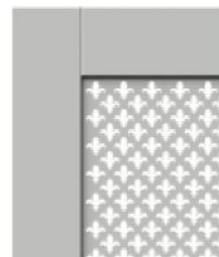

CL 05



CL 02



CL 05

CLASSIC III **NEW!** VÝPLNĚ, RÁM, MŘÍŽKA / VÝPLNE, RÁM, MRIEŽKA / GRILLES TYPES

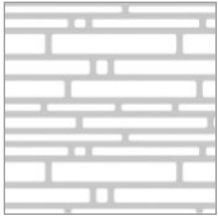

CLA 01

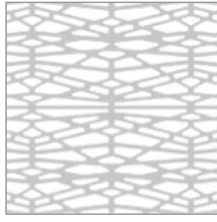

CLA 02

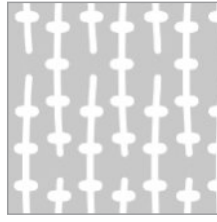

CLA 03

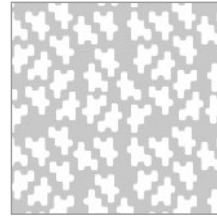

CLA 04

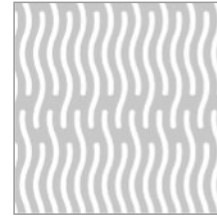

CLA 05

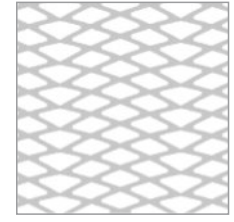

CLA 06

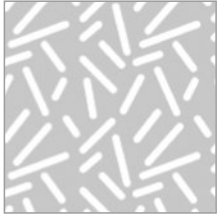

CLA 07

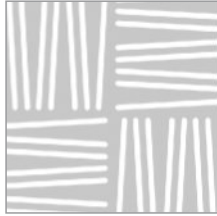

CLA 08

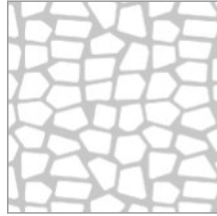

CLA 09

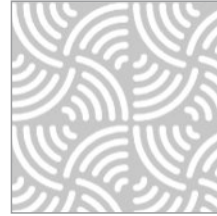

CLA 10

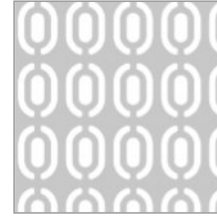

CLA 11

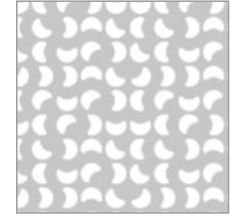

CLA 12

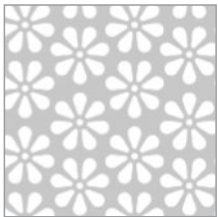

CLA 13

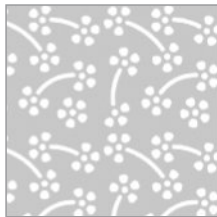

CLA 14

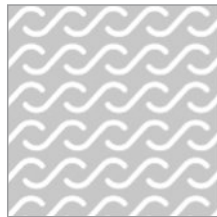

CLA 15

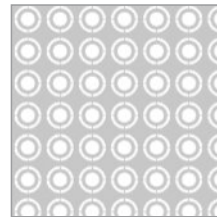

CLA 16



CLA 17

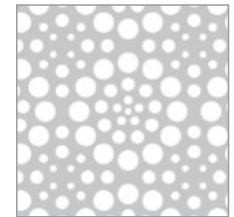

CLA 18



CLA 19

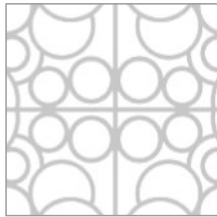

CLA 20

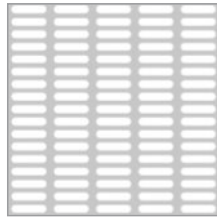

CLA 21

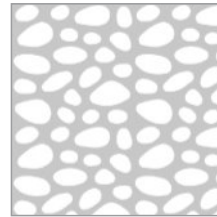

CLA 22



CLA 23



CLA 24

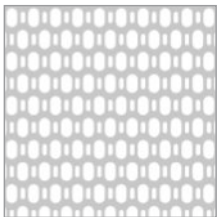

CLA 25

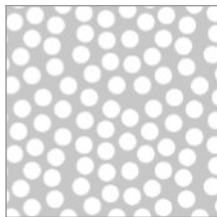

CLA 26

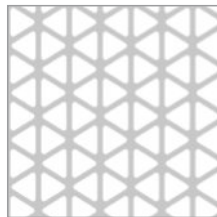

CLA 27

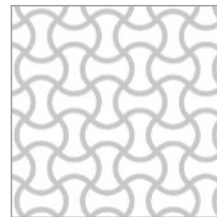

CLA 28

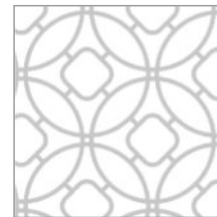

CLA 29



CLA 30

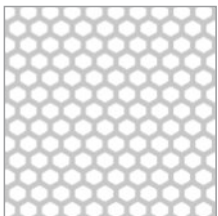

CLA 31

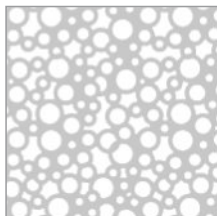

CLA 32

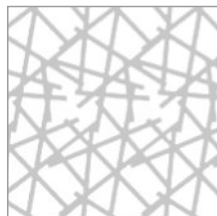

CLA 33



CLA 34

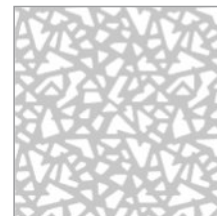

CLA 35

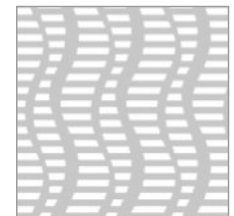

CLA 36

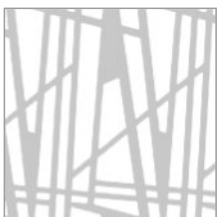

CLA 37

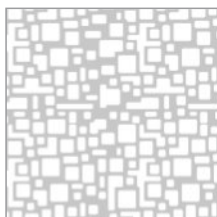

CLA 38



CLA 39

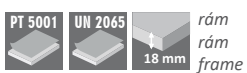

rám
rám
frame



mřížka
mriežka
grid

Rozměry / rozmery / dimensions: 900, 1100, 1300 mm





rám
rám
frame
18 mm



síla mřížky
hrúbka mriežky
the grid strength
6 mm

Modern Line



OLD LINE



skříňka 5 / skrinka 5 / housing 5

boky/boky/sides: 18 mm
parapet/parapet/sill: 28 mm

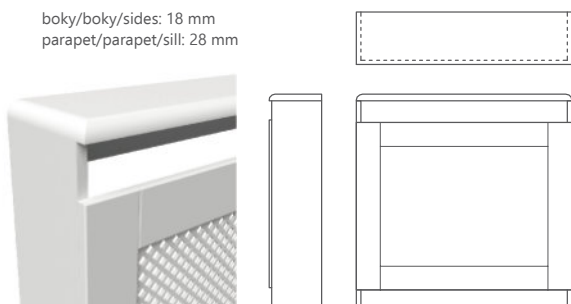

MONTÁŽ DO ZDI SMP07
MONTÁŽ DO STENY SMP07
WALL MOUNTING SMP07

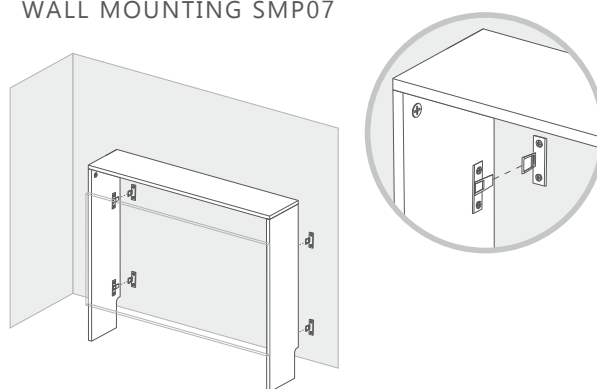

ROZMĚRY KRYTŮ RADIÁTORŮ A SKŘÍŇEK / ROZMERY KRYTOV RADIÁTOROV A SKRINIEK / DIMENSIONS OF RADIATOR COVERINGS AND CABINETS

TYP / TYPE:	700	800	900	1000	1100	1200	1300	1400	1500	1600	1700	1800
šířka / šířka / width:	700	800	900	1000	1100	1200	1300	1400	1500	1600	1700	1800
výška / výška / height:	888	888	888	888	888	888	888	888	888	888	888	888
hloubka / hlúbka / depth:	220	220	220	220	220	220	220	220	220	220	220	220



60 cm

600-1700 cm

DOPORUČENÝ ROZMĚR RADIÁTORU
DOPORUČENÝ ROZMER RADIÁTORA
RECOMMENDED RADIATOR SIZE



SADY KRYTŮ RADIÁTORŮ A SKŘÍŇKY / SADY KRYTOV RADIÁTOROV A SKRINKY /
RADIATOR AND BOX COVER KITS

NEW!



KRYT RADIÁTORU PILO

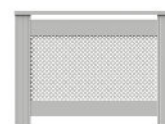

BARVA: bílá
FARBA: biela
COLOR: white

ŠÍŘKA/ŠÍŘKA/WIDTH: 600÷1800 mm
VÝŠKA/VÝŠKA/HEIGHT: 810 mm
HLOUBKA/HĽBKA/DEPTH: 190 mm



KRYT RADIÁTORU EASY

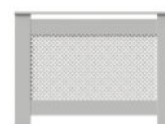
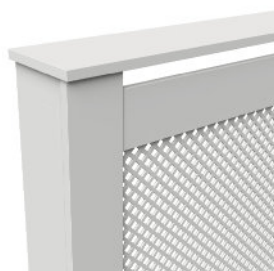

BARVA: bílá
FARBA: biela
COLOR: white

ŠÍŘKA/ŠÍŘKA/WIDTH: 600÷1800 mm
VÝŠKA/VÝŠKA/HEIGHT: 810 mm
HLOUBKA/HĽBKA/DEPTH: 190 mm



MODULOWALL



Drop
UN 5003

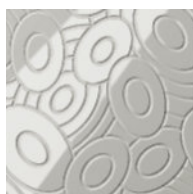

Galaxy
HG 0115



Maze
UN 5004

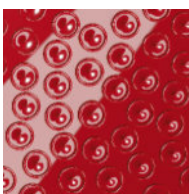

Moon
HG 4200



Rose
HG 0340



Saturn
UN 2065

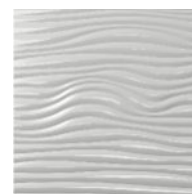

Wave
HG 9700



lak matný
lak matný
matt lacquer



fólie UN,DC,DM, PT
fólia UN,DC,DM, PT
Foil UN,DC,DM, PT



fólie vysoký lesk
fólie vysoký lesk
high gloss foil



surová MDF
surová MDF
raw



12mm

síla
hrúbka
thickness

rozměry/rozmary/dimensions
600 x 600 mm
600 x 1200 mm



MODULOSTYLING



HEXA
UN 5003
rozměry/rozmary/dimensions
350x400 mm



OPI
HG 9700
rozměry/rozmary/dimensions
302x285 mm

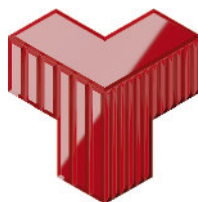

INFINI
HG 4200
rozměry/rozmary/dimensions
369x373 mm



6, 12, 18 mm



10 mm



ZÁHLAVÍ POSTELÍ / ZÁHLAVIE POSTELIE / HEADBOARDS

GALAXY 2 A

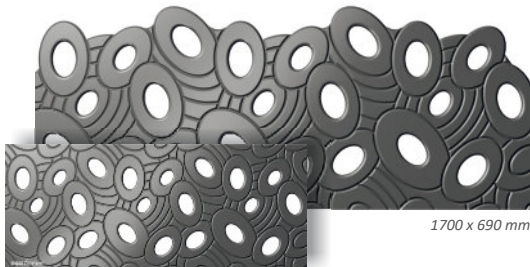

1700 x 690 mm

GALAXY 3 A



1440 x 980 mm

GALAXY 3 B



1590 x 980 mm

GALAXY 1 A

1700 x 700 mm

MOON 1 A



1200 x 800 mm

MOON 1 B



400 x 800 mm

SATURN 1 A



1200 x 900 mm

SATURN 1 B



400 x 900 mm





PT 5001

modulokids

KOLEKCE PRO DĚTI

CZ: ModuloKIDS je nejnovější kolekce dekoračních zařizovacích předmětů dětského nábytku. Nabídka zahrnuje dekorační panely, průhledné dekorační panely v rozměrech na přání a také hotové výrobky jako jsou záhlaví postelí, kryty radiátorů, tabule a doplňky. Tyto prvky jsou povrchově upraveny dekorační fólií PVC nebo nalakované.

KOLEKCIA PRE DETI

SK: ModuloKIDS je najnovšia kolekcia dekoračných zariadených predmetov detského nábytku. Ponuka zahŕňa dekoračné panely, priehľadné dekoračné panely v rozmeroch na želanie a tiež hotové výrobky ako sú čelá postelí, kryty radiátorov, tabule a doplnky. Tieto prvky sú povrchovo upravené dekoračnou fóliou PVC alebo nalakované.

COLLECTION FOR KIDS

EN: ModuloKIDS is the latest collection of decorative items to furniture for children. The offer includes panels and openwork panels to size and finished parts such as the head, grilles, panels and accessories. The elements can be finished in a foil or lacquer-coating.

PANELY moduloKIDS

panely moduloKIDS / moduloKIDS panels



PKA 1 F BALLOONS



PKA 2 F CLOUDS



PKA 3 F CARS



PKA 4 F ZOO

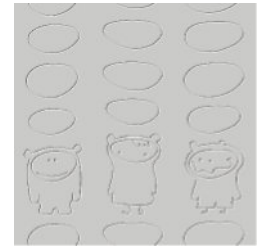

PKA 5 F COSMO



PKA 1 BALLOONS



PKA 2 CLOUDS

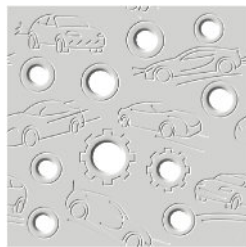

PKA 3 CARS



PKA 4 ZOO

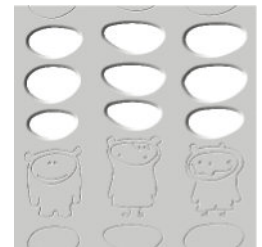

PKA 5 COSMO

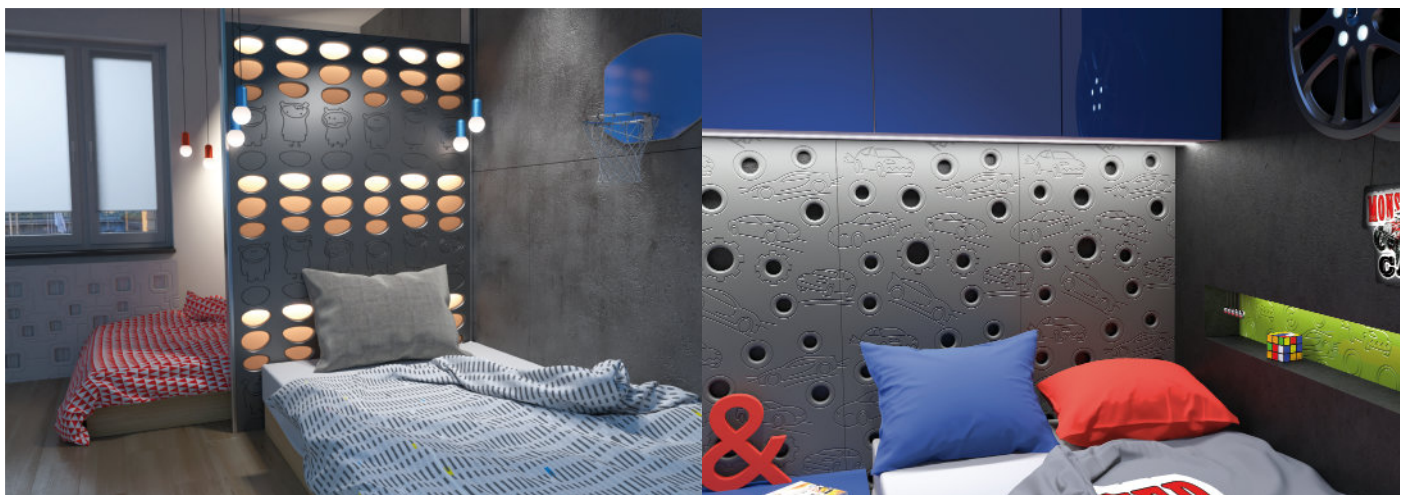

KRYTY RADIÁTORŮ

kryty radiátorov / radiator covers



skříňka 3 / skrinka 3 / housing 3

boky/sides: 28 mm
parapet/sill: 28 mm

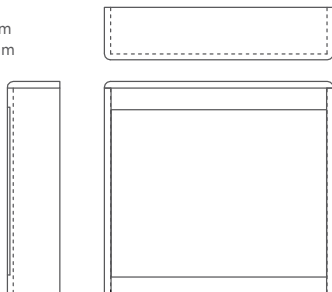

TYP / TYPE:	900	1000	1100	1200	1300	1400
šířka / šířka / width:	956	1056	1156	1256	1356	1456
výška / výška / height:	888	888	888	888	888	888
síla / hrúbka / depth:	220	220	220	220	220	220

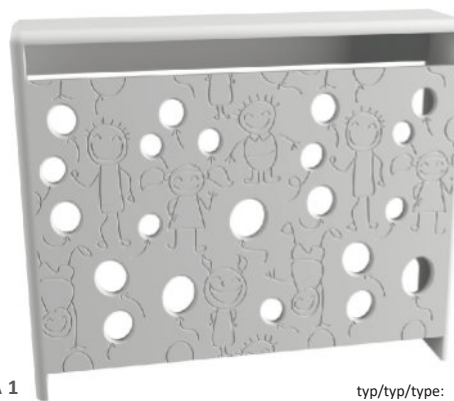

PKA 1
BALLOONS

typ/typ/type:
900,1000,1100,1200,1300,1400



PKA 2
CLOUDS

typ/typ/type:
900,1000,1100,1200,1300,1400



PKA 3
CARS

typ/typ/type:
900,1000,1100,1200,1300,1400

PARAPETY MDF
PARAPETY MDF / WINDOW SILLS MDF

PAR 1

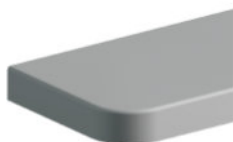

PAR 2



PAR 3



PAR 4

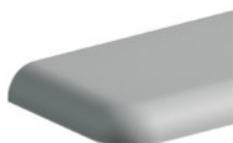

PAR 5



PAR 6



PAR 7



PAR 8

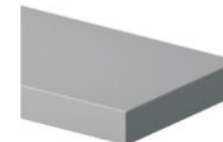

PAR 9

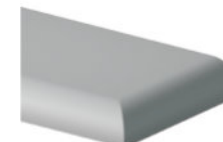

Návod na údržbu nábytkových dvířek PROFORM

Care recommendations

CZ:

Nábytková dvířka PROFORM jsou vyrobena na bázi dřevěných materiálů jako je MDF deska, DTD deska, dýha nebo masivní dřevo a jako takové na nechráněných nebo mechanicky poškozených místech absorbují vlhkost. Proto je třeba při údržbě dbát na kontrolu takovýchto míst, aby se zabránilo nabobtnání dvířek.

Jinak je údržba velmi jednoduchá – v pravidelných intervalech stačí dvířka ofouknout, aby se zbavila prachu, následně je vyčistit 5% mýdlovým roztokem, zbylé mýdlo smýt vodou a utřít dosucha za použití speciální utěrky, která je dostupná na prodejně a v našem eshopu.

Pokud je povrch znečištěn a objeví se jakékoli skvrny, zejména ty způsobené barevnými látkami a tekutinami (jako je hořčice, káva, čaj, červené víno atd.) je nutno co nejdříve umýt vodou a výše popsáním způsobem tak, aby se zabránilo jejich zaschnutí. Po jejich zaschnutí je odstranění obtížné a spočívá v několikerém opakování standardního postupu.

Nepoužívejte čisticí prášek, kartáče nebo ocelovou vlnu! K čištění nejsou vhodné parní vysavače, vysokotlaké čističe a abrazivní houbičky.

POZOR! JE ZAKÁZÁNO POUŽÍVAT SILNÉ ČISTICÍ PROSTŘEDKY, ROZPOUŠTĚDLA, TEKUTINY NEBO PASTY OBSAHUJÍCÍ ABRASIVNÍ ČINIDLA, TEKUTINY NA OKNA, OCET, ČISTIČE NÁBYTKU OBSAHUJÍCÍ VOSK, TVRDÉ HOUBY, PAPIROVÉ RUČNÍKY ATD.

SK:

Nábytkové dvierka PROFORM sú vyrobené na báze drevených materiálov ako je MDF doska, DTD doska, dyha alebo masívne drevo a ako také na nechránených alebo mechanicky poškodených miestach absorbujú vlhkosť. Preto je potrebné pri údržbe dbať na kontrolu takýchto miest, aby sa zabránilo napučaniu dvierok.

Inak je údržba veľmi jednoduchá – v pravidelných intervaloch stačí dvierka ofúknuť, aby sa zbavili prachu, následne ich vyčistiť 5% mydlovým roztokom, zvyšné mydlo zmyť vodou a utrieť dosucha za použitia špeciálnej utierky, ktorá je dostupná na predajni av našom eshope.

Pokiaľ je povrch znečistený a objavia sa akékoľvek škrvny, najmä tie spôsobené farebnými látkami a tekutinami (ako je horčica, káva, čaj, červené víno atď.) je nutné čo najskôr umyť vodou a vyššie popísaným spôsobom tak, aby sa zabránilo ich zaschnutiu. Po ich zaschnutí je odstránenie ťažké a spočíva v niekoľkonásobnom opakovaní štandardného postupu.

Nepoužívajte čistiaci prášok, kefy alebo oceľovú vlnu! Na čistenie nie sú vhodné parné vysávače, vysokotlakové čističe a abrazívne hubky.

POZOR! JE ZAKÁZÁNO POUŽÍVAT SILNÉ ČISTICÍ PROSTŘEDKY, ROZPOUŠTĚDLA, TEKUTINY NEBO PASTY OBSAHUJÍCÍ ABRASIVNÍ ČINIDLA, TEKUTINY NA OKNA, OCET, ČISTIČE NÁBYTKU OBSAHUJÍCÍ VOSK, TVRDÉ HOUBY, PAPIROVÉ RUČNÍKY ATD.

EN:

PROFORM furniture doors are made on the basis of wooden materials such as MDF board, DTD board, veneer or solid wood and as such absorb moisture in unprotected or mechanically damaged areas. Therefore, it is important to check such places during maintenance to prevent swelling of the door.

Otherwise, maintenance is very simple - just blow the door at regular intervals to get rid of dust, then clean it with a 5% soap solution, wash off the remaining soap with water and wipe it dry using a special cloth, which is available at the store and in our e-shop.

If the surface is dirty and any stains appear, especially those caused by colored substances and liquids (such as mustard, coffee, tea, red wine, etc.) it must be washed as soon as possible with water and in the manner described above in order to prevent them from drying. After they dry, their removal is difficult and consists in repeating the standard procedure several times.

Do not use cleaning powder, brushes or steel wool! Steam cleaners, high-pressure cleaners and abrasive sponges are not suitable for cleaning.

ATTENTION! IT IS PROHIBITED TO USE STRONG CLEANING AGENTS, SOLVENTS, LIQUIDS OR PASTE CONTAINING ABRASIVE AGENTS, WINDOW FLUIDS, VINEGAR, FURNITURE CLEANERS CONTAINING WAX, HARD SPONGES, PAPER TOWELS, ETC.